



JBC

The Soldering Co.

Cartridge Guide

Feel the quality, be exclusive

Index

Most Efficient Soldering System.....	4
Bigger is better	6
Factors limiting tip life.....	7
Tip Cleaning Systems	8
C115 Cartridge Range for NT115, AN115 and NP115 Nano Tools.....	12
C120 Cartridge Range for PA120 and AM120 Micro Tweezers.....	16
C210 Cartridge Range for T210 Precision Handles	18
C245 Cartridge Range for T245 General Purpose Handles.....	22
C245E Extended Tip Life Cartridge Range for T245 General Purpose Handles	44
C250 Cartridge Range for ALE250 Auto-Feed Iron and AP250 Solder Feed Iron	46
C420 Cartridge Range for AT420 and HT420 Thermal Tweezers.....	49
C470 Cartridge Range for T470 HD Handles and HT470 HD Thermal Tweezers	51
C360 Tip Range for DS360 Micro Desoldering Iron	59
C560 Tip Range for DR560 Desoldering Iron.....	61
W140 Blade Cartridge Range for WS140 Precision High-Temperature Wire Stripper Tweezers	63
W440 Blade Cartridge Range for WS440 High-Temperature Wire Stripper Tweezers	65

A global organization at your service

JBC is a global company with a distributor network spanning 5 continents that guarantees a solid commercial organization with quick and efficient service.

The power of experience

More than 90 years of experience have placed JBC at the technological forefront of tools for soldering and rework operations in electronics. Innovation, efficiency and reliability are the key features of a wide range of products which have been designed to satisfy the most demanding requirements of professionals.

High technology, superior quality

Product perfection is one of the main objectives of JBC's improvement and development program.

The R&D department has created the most innovative soldering technologies, which JBC is proud to present in this catalogue.



All JBC products comply with CE standards and ESD recommendations.



JBC Technology

Most Efficient Soldering System

JBC Stations work with JBC Most Efficient Soldering System, which **recovers tip temperature extremely quickly**. This increases work efficiency and allows the user to work with lower temperatures.

Efficient Temperature Control
Comparative process of 3 solder joints

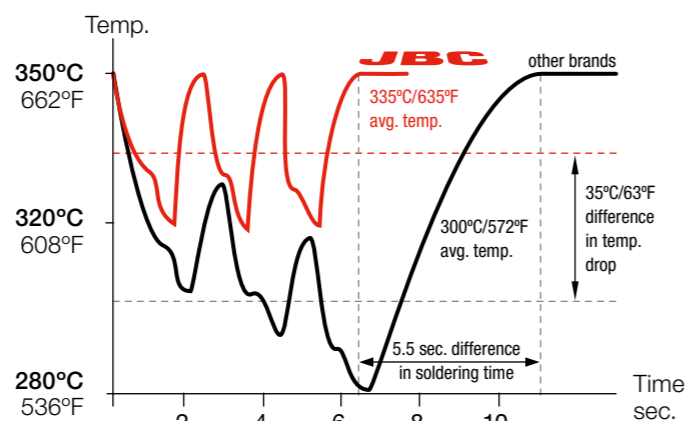

Tips with JBC Technology only drop 30°C (54°F) where others drop as much as 70°C (126°F).

Enhanced Temperature Efficiency → Increased Productivity + Better Quality

Productivity

Short tip-to-sensor distance ensures extremely quick temperature recovery and an **accurate control**.

Heating System Principles
350°C/662°F in 2 seconds

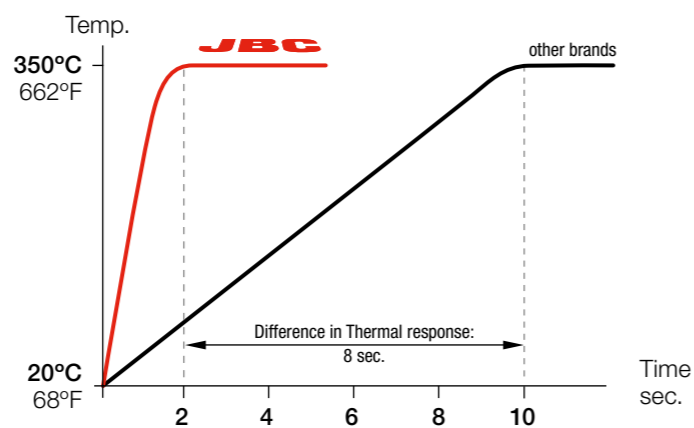

This graph compares JBC C210 Cartridge Range to the equivalent cartridges of the best competitor.

Intelligent Heat Management

Thanks to automatic detection of the tool in the stand, JBC Soldering & Rework Stations allow the tools to enter **Sleep & Hibernation Modes** when not being used. As a result, tip life lasts up to 5 times longer.

Sleep Mode

Sleep Mode **automatically lowers tip temperature** below the solder melting point when the tool rests in the stand. It prevents the dissolution of the iron tip coating into molten solder.

Hibernation Mode

After a configurable period of tool inactivity in the stand, the tool enters Hibernation Mode. It **cuts off the power supply** making the tip reach room temperature, thus **preventing oxidation and saving energy**.

Longer Tip life

Tip life increases exponentially by **using lower temperatures** as shown. Using Sleep Mode, the temperature is further reduced, which **multiplies tip life by 5**.

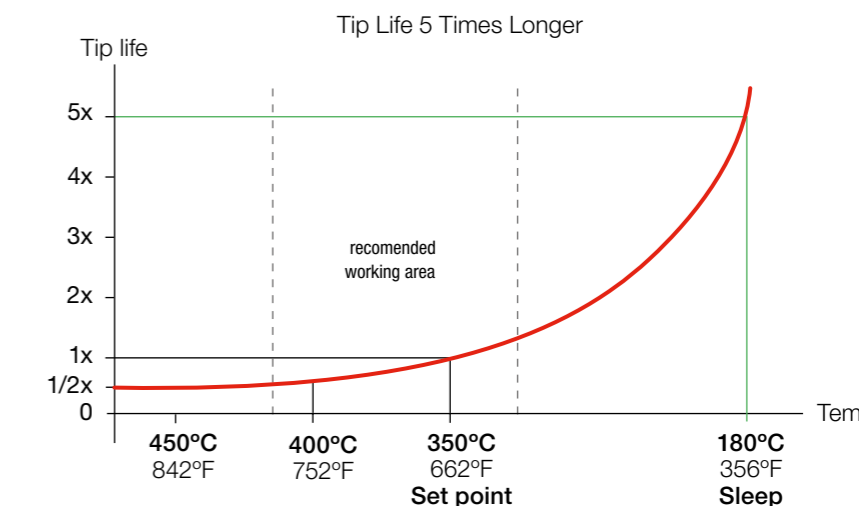
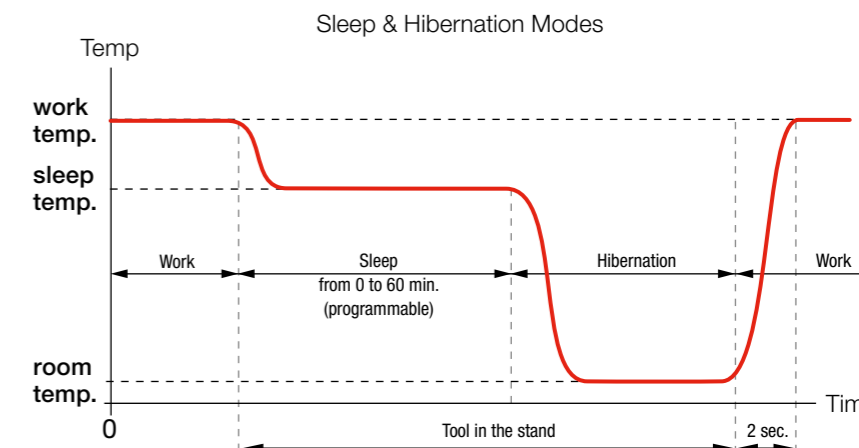

Cartridges with long life & extended tip life

The essential part of the soldering iron is the tip. Therefore, JBC has **over 500 cartridge models of different shapes and sizes** to choose from, depending on each application. JBC has developed the most advanced technology based on the following principles:

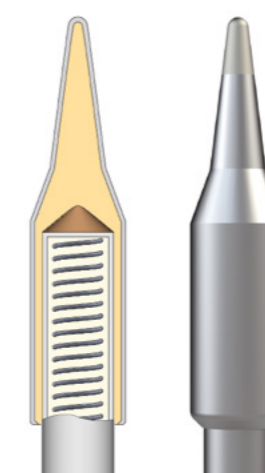

- **Excellent Heat Transfer**
The compact element reduces thermal barriers.
- **Instantaneous Heating**
A fully-integrated thermal sensor in the heater ensures quick temperature recovery.
- **Great Durability**
The intelligent algorithm control program extends tip life.

When you start working do not forget:

Bigger is better

The bigger the solder tip, the better the thermal transfer. Select the tip that has the greatest contact area.

Over 500 tips of different sizes, shapes and power

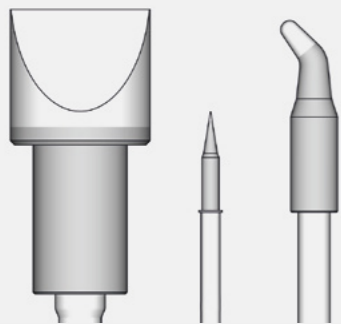

JBC Cartridges range from models for precision work to high power requirement applications.

Geometry Slimness vs Efficiency

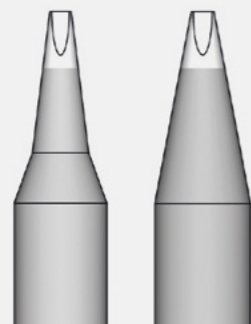

A tip with high-thermal efficiency makes your job up to **40% faster** than a tip with a slimmer geometry.

Increase the contact surface Tip - Application

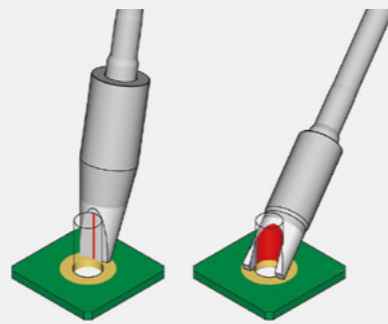

The bigger the contact surface that the tip has with the application, the higher the **thermal transfer**.

Largest mass possible

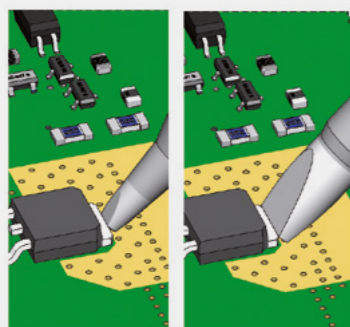

The more mass the tip has, the more heat is accumulated and the **lower is the temperature drop**.

Maintain tip surface clean and tinned



Remember that rusty and dirty surfaces reduce **heat transfer** to the solder joint.
(See JBC's cleaning methods on pages 8-9).

This way you will be able to:

- Work at **lower temperatures** (350°C / 662°F).
- Obtain **better results** in **less time**.
- Improve **thermal performance**.
- Increase **temperature precision**.
- Reduce **collateral damage** (thermal shock on components and PCBs).

Factors limiting tip life

Working temperature

The higher the temperature, the greater the oxidation and corrosion. Work with the **lowest possible temperature** and choose the tip with the greatest contact area for each application. **Use thermally efficient tools** and keep tips clean of oxidation.

Correct techniques

Too much pressure on the surface to solder can cause tip or plate breakage. Do not use the tip as a pointed object or a screwdriver. Choose the **right temperature and tip shape for each application**.

Iron plate thickness

Iron plate wear shortens tip life by hollowing tips out. Do not use mechanical or chemical means to clean the tip. Use the **cleaning methods provided by the manufacturer** - such as brass wool, automatic tip cleaner or sponges.

Oxidization

An oxidized soldering iron does neither wet nor transfer heat well (dewetting). The higher the temperature, the greater the risk of oxidation. **Always keep tips tinned while not in use** and take advantage of **JBC Sleep & Hibernation Modes**.

Flux and solder alloy

Too much active flux can cause corrosion. **IPC recommends: ROL, REL and ORL.** Flux quantity inside small diameter solder wires might not be enough. **Provide compatible external flux if necessary.**

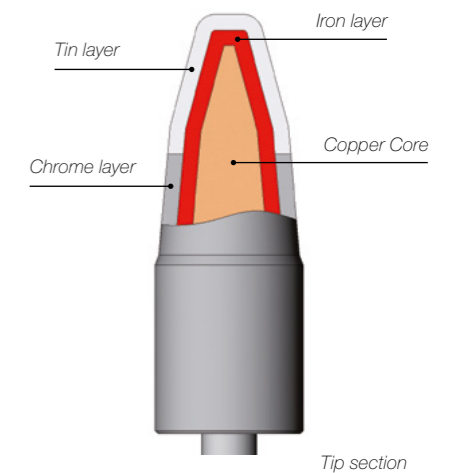

Tip section

Remember:

- Work with the **lowest possible temperature**.
- Use **thermally efficient tools**.
- Choose the **right temperature and tip shape for each application**.
- **IPC recommends: ROL, REL and ORL.**
- **Always keep tips tinned while not in use.**
- Take advantage of **JBC Sleep & Hibernation Modes**.
- **Too much pressure** on the surface to solder can cause **tip or plate breakage**.
- Use the **cleaning methods provided by the manufacturer**.



Cleaning Systems

For good thermal transfer, keep the tip tinned thus free from oxides.

JBC offers effective, practical and affordable methods to prevent splashing and extend tip life:

Clean the tip in less than a second



With automatic cleaners you **save time** and optimize production.

Improve heat transfer

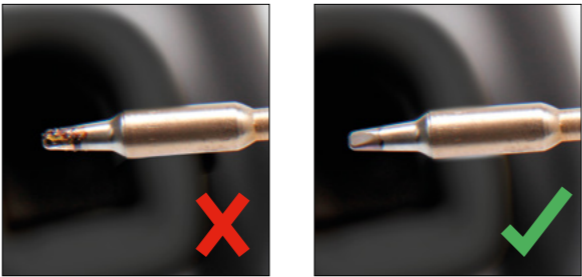

A clean tip is always easier to tin, resulting in **higher quality solder joints**.

Easy to empty



The solder collector tray can be **easily emptied** and re-used with no wear and tear.

Keep your workspace clean



The locking mechanism on the brushes makes them **fast and easy to replace**.

CL Manual Tip Cleaner

A complete cleaning system with splashguard and antisplash membrane to keep the workspace clean and free of solder particles.



CLMS Junior Tip Cleaner

The ideal partner to any soldering station.

Two modes of operation

The motorized brushes start by pushing the button or by selecting the continuous mode.



Save space

You can easily fit the tip cleaner into your workspace thanks to its reduced size.

Brushes

CL4008

Fiber Brushes
The composition, size and thickness of the fibers ensure the **most efficient cleaning** and the least damage while cleaning the tip.



CLMUP Automatic Tip Cleaner with Fiber Brushes (non-metal)



It also features a second position which facilitates vertical tip access

CLMU Automatic Tip Cleaner with Metal Brushes



These cleaners are excellent for cleaning tips of different shapes and sizes. You can easily switch between sensor and continuous mode by pressing the top buttons.

Brushes

CL2008 / CL2007

Fiber Brushes provides a **soft cleaning**, especially recommended for regular usage to improve tip life.



CL1008 / CL1007

Metal Brushes provides a **thorough cleaning to recover the tip**, increasing heat transfer. Supplied with CLMU.



Cleaning Methods

CL6210

Brass Wool

Very effective cleaning method. It leaves a small layer of solder on the tip to prevent oxidation between cleaning and rewetting.



S0354

Sponge

The least harmful cleaning method. Keep the sponge moist with distilled water when working to avoid tip wear.





Our Cartridge Range is steadily growing as we are determined to respond to our clients' specific needs, cooperating closely with them to create **the right solution.**

C115 Cartridge Range
for **NT115, AN115** and **NP115** Nano Tools



Ref.	Description	Image and dimensions	Suggested components	Compatible with
C115116	Chisel Cartridge 0.2 x 0.1 mm 0.008 x 0.004 in		Package 01005, 0201 Very fine pitch 0.4 mm QFP, IC	Stations: NASE, NANE Tools: NT115, AN115, NP115
C115117	Chisel Cartridge 0.4 x 0.2 mm 0.016 x 0.008 in		Package 0402 Very fine pitch 0.65 mm QFP, IC	Stations: NASE, NANE Tools: NT115, AN115, NP115
C115108	Chisel Cartridge 0.6 x 0.3 mm 0.024 x 0.012 in		Package 0603 PLCC, SO, SOT	Stations: NASE, NANE Tools: NT115, AN115, NP115
C115125	Chisel Cartridge 1 x 0.2 mm 0.039 x 0.008 in		Package 0805 Difficult to reach	Stations: NASE, NANE Tools: NT115, AN115, NP115
C115113	Chisel Cartridge 1 x 0.3 mm 0.039 x 0.012 in		Package 0805 Through-hole	Stations: NASE, NANE Tools: NT115, AN115, NP115
C115213	Chisel Cartridge 1 x 0.3 S1 mm 0.039 x 0.012 in		Package 0805 Through-hole High-thermal performance	Stations: NASE, NANE Tools: NT115, AN115, NP115
C115221	Chisel Cartridge 1.3 x 0.3 mm 0.051 x 0.012 in		Package 0805 Through-hole High-thermal performance	Stations: NASE, NANE Tools: NT115, AN115, NP115



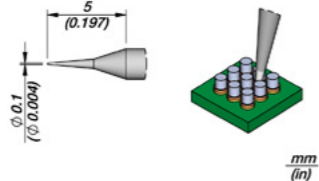
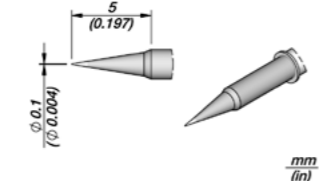
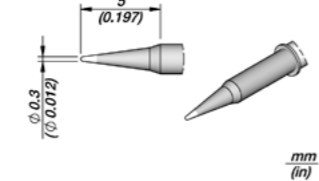
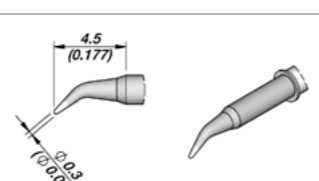

C115 Cartridge Range for NT115, AN115 and NP115 Nano Tools

Ref.	Description	Image and dimensions	Suggested components	Compatible with
C115222	Chisel Cartridge 1.6 x 0.3 mm 0.063 x 0.012 in		Package 0805 Through-hole High-thermal performance	Stations: NASE, NANE Tools: NT115, AN115, NP115
C115114	Chisel Cartridge 1.8 x 0.5 mm 0.071 x 0.020 in		Package 0805 Through-hole	Stations: NASE, NANE Tools: NT115, AN115, NP115
C115214	Chisel Cartridge 1.8 x 0.5 mm S1 0.071 x 0.020 in		Package 1206, 1210 Through-hole High-thermal performance	Stations: NASE, NANE Tools: NT115, AN115, NP115
C115131	Chisel Cartridge 2 x 0.35 mm 0.079 x 0.014 in		LED SMD 2727, 1921, 1415	Stations: NASE, NANE Tools: NT115, AN115, NP115
C115223	Chisel Cartridge 2.4 x 0.6 mm 0.094 x 0.024 in		Package 0805 Through-hole High-thermal performance	Stations: NASE, NANE Tools: NT115, AN115, NP115
C115109	Bevel Cartridge Ø 0.6 mm Ø 0.024 in		Drag soldering SMD Through-hole	Stations: NASE, NANE Tools: NT115, AN115, NP115
C115127	Bevel Cartridge Ø 1 mm Ø 0.039 in		Drag soldering SMD Through-hole	Stations: NASE, NANE Tools: NT115, AN115, NP115
C115128	Spoon Cartridge Ø 1 mm Ø 0.039 in		Drag soldering SMD Through-hole	Stations: NASE, NANE Tools: NT115, AN115, NP115

C115 Cartridge Range for NT115, AN115 and NP115 Nano Tools

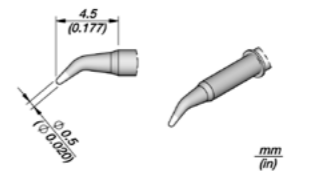
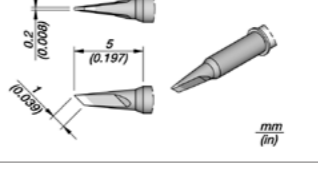
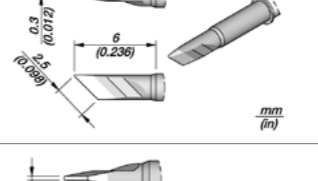
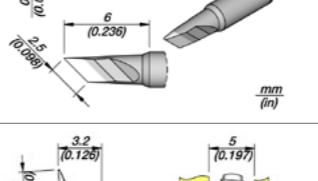
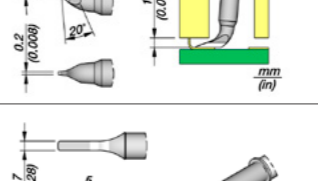
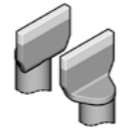
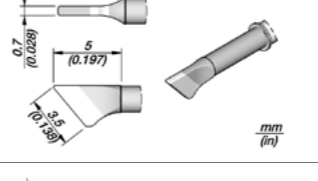
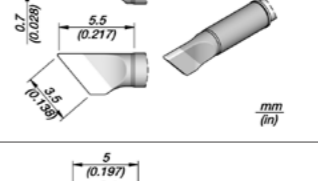
	Ref.	Description	Image and dimensions	Suggested components	Compatible with
	C115126	Conical Cartridge Ø 0.1 mm S1 Ø 0.004 in		Package 01005 Very fine pitch 0.4 mm QFP, IC	Stations: NASE, NANE Tools: NT115, AN115, NP115
	C115101	Conical Cartridge Ø 0.1 mm Ø 0.004 in		Package 01005 Very fine pitch 0.4 mm QFP, IC	Stations: NASE, NANE Tools: NT115, AN115, NP115
	C115103	Conical Cartridge Ø 0.3 mm S1 Ø 0.012 in		Package 0201, 0402 Very fine pitch 0.65 mm QFP, IC	Stations: NASE, NANE Tools: NT115, AN115, NP115
	C115106	Conical Cartridge Ø 0.5 mm Ø 0.020 in		Package 0603 QFP, IC	Stations: NASE, NANE Tools: NT115, AN115, NP115
	C115107	Conical Cartridge Ø 0.8 mm Ø 0.031 in		General use	Stations: NASE, NANE Tools: NT115, AN115, NP115
	C115124	Conical Bent Cartridge Ø 0.1 mm S1 Ø 0.004 in		Package 01005 Very fine pitch 0.4 mm QFP, IC	Stations: NASE, NANE Tools: NT115, AN115, NP115
	C115118	Conical Bent Cartridge Ø 0.1 mm Ø 0.004 in		Package 01005 Very fine pitch 0.4 mm QFP, IC	Stations: NASE, NANE Tools: NT115, AN115, NP115
C115105	Conical Bent Cartridge Ø 0.3 mm Ø 0.012 in		Package 0201, 0402 Fine pitch 0.65 mm QFP, IC	Stations: NASE, NANE Tools: NT115, AN115, NP115	

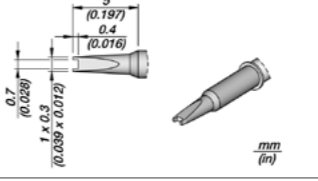
C115 Cartridge Range for NT115, AN115 and NP115 Nano Tools

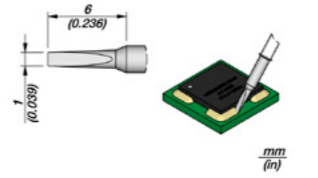
	Ref.	Description	Image and dimensions	Suggested components	Compatible with
	C115110	Conical Bent Cartridge Ø 0.5 mm Ø 0.020 in		Package 0603 QFP, IC	Stations: NASE, NANE Tools: NT115, AN115, NP115
	C115120	Knife Cartridge 1 x 0.2 mm 0.039 x 0.008 in		Drag soldering SMD Package 0805 Through-hole	Stations: NASE, NANE Tools: NT115, AN115, NP115
	C115112	Knife Cartridge 2.5 x 0.3 mm 0.098 x 0.012 in		Drag soldering SMD SO, SOT Package 1210, 1812, 2010, 2512	Stations: NASE, NANE Tools: NT115, AN115, NP115
	C115212	Knife Cartridge 2.5 x 0.3 mm S1 0.098 x 0.012 in		Drag soldering SMD SO, SOT Package 1210, 1812, 2010, 2512 High-thermal performance	Stations: NASE, NANE Tools: NT115, AN115, NP115
	C115129	Knife Cartridge 2.8 x 0.2 mm 0.110 x 0.008 in		IC, Difficult to reach	Stations: NASE, NANE Tools: NT115, AN115, NP115
		C115111	Blade Cartridge 3.5 x 0.7 mm 0.138 x 0.028 in		Package 1210, 1812 SO, SOT
C115211		Blade Cartridge 3.5 x 0.7 mm S1 0.138 x 0.028 in		Package 1210, 1812 SO, SOT High-thermal performance	Stations: NASE, NANE Tools: NT115, AN115, NP115
	C115132	Chip Components Cartridge 0.7 mm 0.028 in		Package 0201	Stations: NASE, NANE Tools: NT115, AN115, NP115
	C115115	Conformal Coating Removal Steel Cartridge 1 mm 0.039 in		Stainless Steel Remove underfill encapsulants	Stations: NASE, NANE Tools: NT115, AN115, NP115



C120 Cartridge Range
for **PA120** and **AM120** Micro Tweezers

	Ref.	Description	Image and dimensions	Suggested components	Compatible with
	C120001	Conical Bent Cartridge Ø 0.2 mm Ø 0.008 in		Package 0201, 0402	Stations: CP, DI, DDE, DME Tools: AM120, PA120
	C120002	Conical Bent Cartridge Ø 0.2 mm Ø 0.008 in		Package 0201, 0402	Stations: CP, DI, DDE, DME Tools: AM120, PA120
	C120902	Conical Bent Cartridge Ø 0.3 mm Ø 0.012 in		Package 0201, 0402 Fine pitch 0.65 mm QFP, IC	Stations: CP, DI, DDE, DME Tools: AM120, PA120
	C120006	Conical Bent Cartridge Ø 0.5 mm Ø 0.020 in		Package 0603 QFP, IC	Stations: CP, DI, DDE, DME Tools: AM120, PA120
	C120004	Conical Bent Cartridge Ø 0.7 mm S1 Ø 0.028 in		SMD capacitors QFP, IC Through-hole	Stations: CP, DI, DDE, DME Tools: AM120, PA120
	C120012	Conical Bent Cartridge Ø 0.7 mm S2 Ø 0.028 in		SMD capacitors QFP, IC Through-hole Tip with an extra tinned surface	Stations: CP, DI, DDE, DME Tools: AM120, PA120
		C120011	Chisel Bent Cartridge 0.6 x 0.3 mm 0.024 x 0.012 in		Package 0603

C120 Cartridge Range for PA120 and AM120 Micro Tweezers



	Ref.	Description	Image and dimensions	Suggested components	Compatible with
	C120013	Blade Cartridge 2 mm 0.079 in		LED SMD 2727, 1921, 1415	Stations: CP, DI, DDE, DME Tools: AM120, PA120
	C120003	Blade Cartridge 3 mm 0.118 in		Package 1210, 1812 SO, SOT	Stations: CP, DI, DDE, DME Tools: AM120, PA120
	C120007	Blade Cartridge 3.5 mm Right 0.138 in		Package 1210, 1812 SO, SOT	Stations: CP, DI, DDE, DME Tools: AM120, PA120
	C120008	Blade Cartridge 3.5 mm Left 0.138 in		Package 1210, 1812 SO, SOT	Stations: CP, DI, DDE, DME Tools: AM120, PA120
	C120005	Blade Cartridge 5 mm 0.197 in		SO, SOT	Stations: CP, DI, DDE, DME Tools: AM120, PA120
	C120009	Blade Cartridge 6 mm Right 0.236 in		SO, SOT	Stations: CP, DI, DDE, DME Tools: AM120, PA120
	C120010	Blade Cartridge 6 mm Left 0.236 in		SO, SOT	Stations: CP, DI, DDE, DME Tools: AM120, PA120



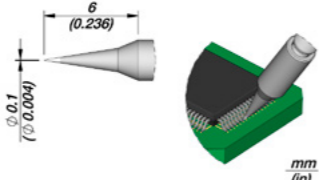
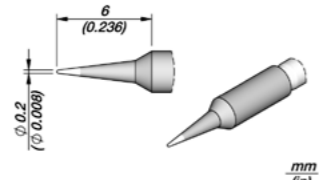
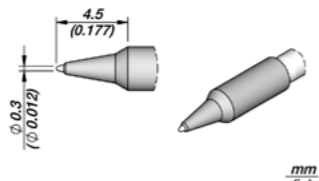
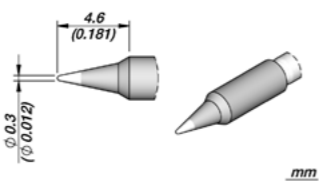
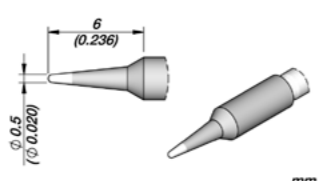
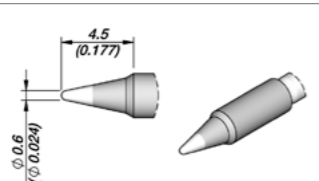
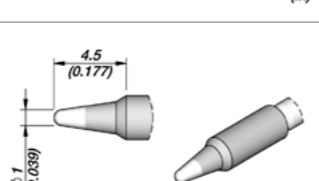

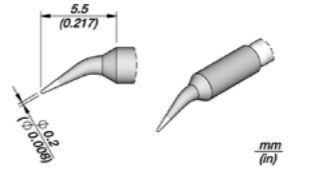
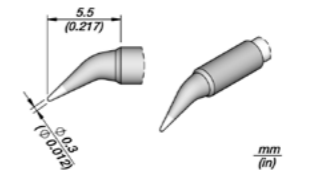
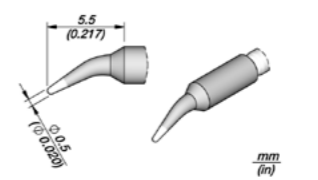
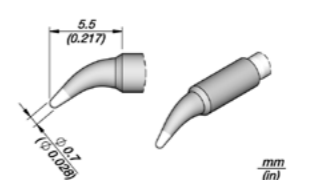

C210 Cartridge Range
for **T210** Precision Handles

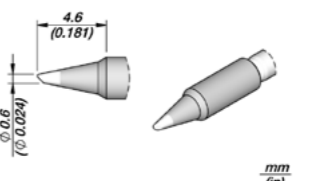
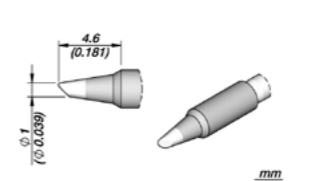
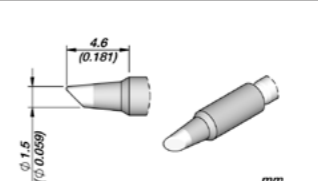
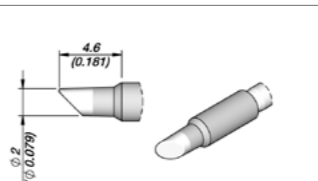
	Ref.	Description	Image and dimensions	Suggested components	Compatible with
	C210020	Conical Cartridge Ø 0.1 mm Ø 0.004 in		Package 01005, 0201 Very fine pitch 0.4 mm QFP, IC	Stations: CDS, CDES, DI, DDE, DME Tools: T210, T210P, T210N
	C210009	Conical Cartridge Ø 0.2 mm Ø 0.008 in		Package 01005, 0201 Very fine pitch 0.4mm QFP, IC	Stations: CDS, CDES, DI, DDE, DME Tools: T210, T210P, T210N
	C210016	Conical Cartridge Ø 0.3 mm S1 Ø 0.012 in		Package 0201, 0402 Fine pitch 0.65 mm QFP, IC	Stations: CDS, CDES, DI, DDE, DME Tools: T210, T210P, T210N
	C210001	Conical Cartridge Ø 0.3 mm S2 Ø 0.012 in		Package 0201, 0402 Fine pitch 0.65 mm QFP, IC	Stations: CDS, CDES, DI, DDE, DME Tools: T210, T210P, T210N
	C210013	Conical Cartridge Ø 0.5 mm Ø 0.020 in		Package 0603 QFP, IC	Stations: CDS, CDES, DI, DDE, DME Tools: T210, T210P, T210N
	C210003	Conical Cartridge Ø 0.6 mm Ø 0.024 in		General use	Stations: CDS, CDES, DI, DDE, DME Tools: T210, T210P, T210N
	C210005	Conical Cartridge Ø 1 mm Ø 0.039 in		General use	Stations: CDS, CDES, DI, DDE, DME Tools: T210, T210P, T210N



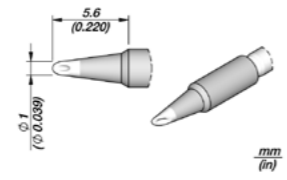
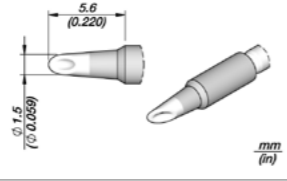
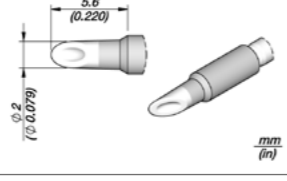

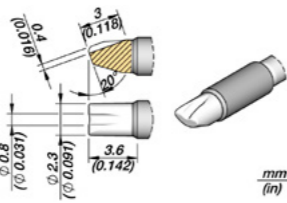

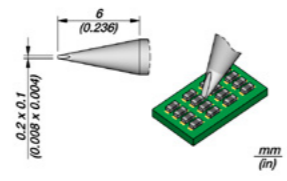
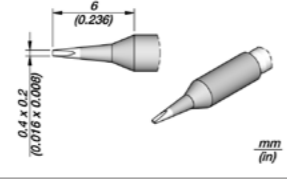
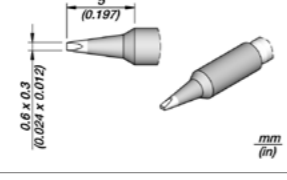
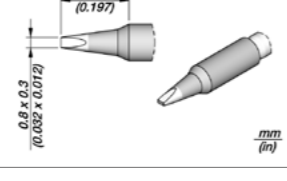
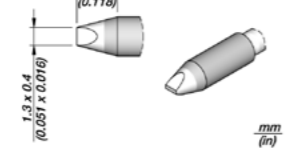
C210 Cartridge Range for T210 Precision Handles

	Ref.	Description	Image and dimensions	Suggested components	Compatible with
	C210002	Conical Bent Cartridge Ø 0.2 mm Ø 0.008 in		Package 0201, 0402	Stations: CDS, CDES, DI, DDE, DME Tools: T210, T210P, T210N
	C210010	Conical Bent Cartridge Ø 0.3 mm Ø 0.012 in		Package 0201, 0402 Fine pitch 0.65 mm QFP, IC	Stations: CDS, CDES, DI, DDE, DME Tools: T210, T210P, T210N
	C210014	Conical Bent Cartridge Ø 0.5 mm Ø 0.020 in		Package 0603 QFP, IC	Stations: CDS, CDES, DI, DDE, DME Tools: T210, T210P, T210N
	C210004	Conical Bent Cartridge Ø 0.7 mm Ø 0.028 in		General use	Stations: CDS, CDES, DI, DDE, DME Tools: T210, T210P, T210N
	C210036	Bevel Cartridge Ø 0.6 mm Ø 0.024 in		Drag Soldering General use	Stations: CDS, CDES, DI, DDE, DME Tools: T210, T210P, T210N
	C210006	Bevel Cartridge Ø 1 mm Ø 0.039 in		Drag Soldering General use	Stations: CDS, CDES, DI, DDE, DME Tools: T210, T210P, T210N
	C210027	Bevel Cartridge Ø 1.5 mm Ø 0.059 in		Drag Soldering General use	Stations: CDS, CDES, DI, DDE, DME Tools: T210, T210P, T210N
	C210031	Bevel Cartridge Ø 2 mm Ø 0.079 in		Drag Soldering General use	Stations: CDS, CDES, DI, DDE, DME Tools: T210, T210P, T210N

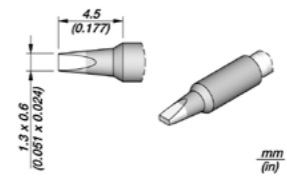
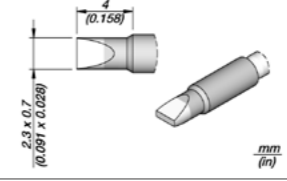
C210 Cartridge Range for T210 Precision Handles

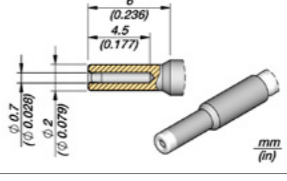
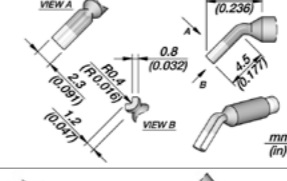
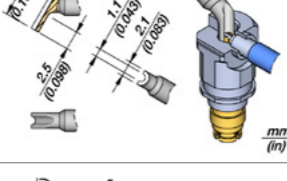
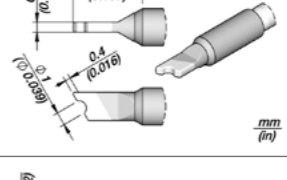
	Ref.	Description	Image and dimensions	Suggested components	Compatible with
	C210028	Spoon Cartridge Ø 1 mm Ø 0.039 in		Drag soldering	Stations: CDS, CDES, DI, DDE, DME Tools: T210, T210P, T210N
	C210029	Spoon Cartridge Ø 1.5 mm Ø 0.059 in		Drag soldering	Stations: CDS, CDES, DI, DDE, DME Tools: T210, T210P, T210N
	C210030	Spoon Cartridge Ø 2 mm Ø 0.079 in		Drag soldering	Stations: CDS, CDES, DI, DDE, DME Tools: T210, T210P, T210N
	C210038	Barrell Cartridge Ø 8 mm Ø 0.031 in		Through-hole Cable soldering / desoldering	Stations: CDS, CDES, DI, DDE, DME Tools: T210 handles
	C210019	Chisel Cartridge 0.2 x 0.1 mm 0.008 x 0.004 in		Package 01005, 0201 Very fine pitch 0.4 mm QFP, IC	Stations: CDS, CDES, DI, DDE, DME Tools: T210, T210P, T210N
	C210023	Chisel Cartridge 0.4 x 0.2 mm 0.016 x 0.008 in		Package 0402 Very fine pitch 0.65 mm QFP, IC	Stations: CDS, CDES, DI, DDE, DME Tools: T210, T210P, T210N
	C210021	Chisel Cartridge 0.6 x 0.3 mm 0.024 x 0.012 in		Package 0603	Stations: CDS, CDES, DI, DDE, DME Tools: T210, T210P, T210N
	C210024	Chisel Cartridge 0.8 x 0.3 mm 0.032 x 0.012 in		Package 0805 Through-hole	Stations: CDS, CDES, DI, DDE, DME Tools: T210, T210P, T210N
	C210022	Chisel Cartridge 1.3 x 0.4 mm 0.051 x 0.016 in		Package 0805 Through-hole	Stations: CDS, CDES, DI, DDE, DME Tools: T210, T210P, T210N

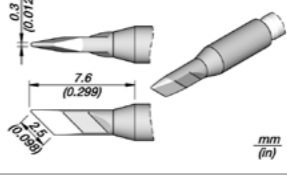
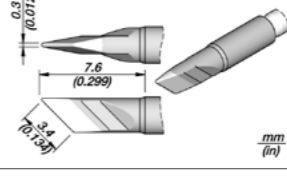
C210 Cartridge Range for T210 Precision Handles

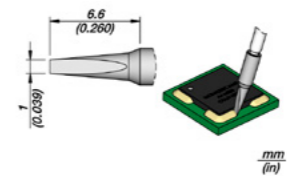
	Ref.	Description	Image and dimensions	Suggested components	Compatible with
	C210008	Chisel Cartridge 1.3 x 0.6 mm 0.051 x 0.024 in		Package 0805 Through-hole	Stations: CDS, CDES, DI, DDE, DME Tools: T210, T210P, T210N
	C210007	Chisel Cartridge 2.3 x 0.7 mm 0.091 x 0.028 in		Package 0805 Through-hole	Stations: CDS, CDES, DI, DDE, DME Tools: T210, T210P, T210N
	C210017	Pin Cartridge Ø 0.7 mm Ø 0.028 in		Through-hole	Stations: CDS, CDES, DI, DDE, DME Tools: T210, T210P, T210N
	C210015	Pin/Connector Cartridge Ø 0.8 mm Ø 0.032 in		Through-hole Coaxial connector	Stations: CDS, CDES, DI, DDE, DME Tools: T210, T210P, T210N
	C210025	Pin/Connector Cartridge Ø 1.1 mm Ø 0.043 in		Through-hole Coaxial connector	Stations: CDS, CDES, DI, DDE, DME Tools: T210, T210P, T210N
	C210012	Pin/Wire Cartridge Ø 1 mm Ø 0.039 in		Cables Connectors	Stations: CDS, CDES, DI, DDE, DME Tools: T210, T210P, T210N
	C210033	Knife Cartridge 2.5 x 0.3 mm 0.098 x 0.012 in		Drag soldering SMD SO, SOT Package 1210, 1812, 2010, 2512	Stations: CDS, CDES, DI, DDE, DME Tools: T210, T210P, T210N
	C210018	Knife Cartridge 3.4 x 0.3 mm 0.134 x 0.012 in		Drag soldering SMD SO, SOT Package 1210, 1812, 2010, 2512	Stations: CDS, CDES, DI, DDE, DME Tools: T210, T210P, T210N
	C210034	Conformal Coating Removal Steel Cartridge 1 x 0.1 mm 0.039 x 0.004 in		Stainless Steel Remove underfill encapsulants	Stations: CDS, CDES, DI, DDE, DME Tools: T210, T210P, T210N

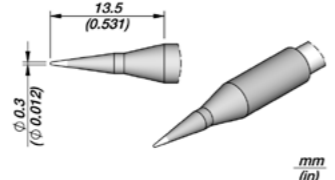
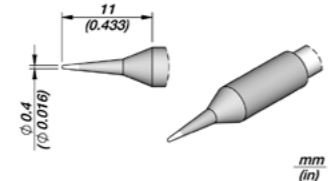
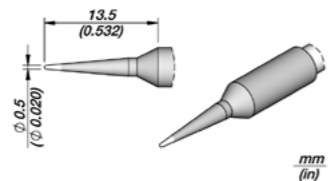
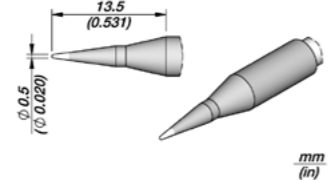
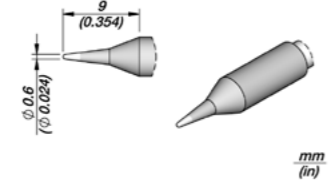
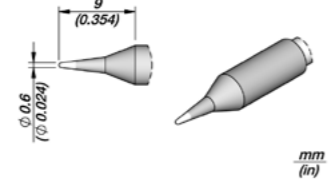
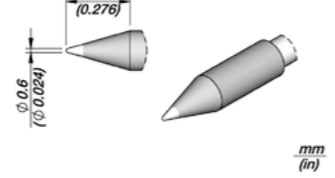

C245 Cartridge Range
for T245 General Purpose Handles

	Ref.	Description	Image and dimensions	Suggested components	Compatible with
	C245030	Conical Cartridge Ø 0.3 mm Ø 0.012 in		Package 0201, 0402 Fine pitch 0.65 mm QFP, IC	Stations: CDB, CDEB, DI, DDE, DME Tools: T245, T245G, T245P, T245N
	C245032	Conical Cartridge Ø 0.4 mm Ø 0.016 in		Package 0201, 0402 Fine pitch 0.65 mm QFP, IC	Stations: CDB, CDEB, DI, DDE, DME Tools: T245, T245G, T245P, T245N
	C245036	Conical Cartridge Ø 0.5 mm S1 Ø 0.020 in		Package 0603 QFP, IC	Stations: CDB, CDEB, DI, DDE, DME Tools: T245, T245G, T245P, T245N
	C245930	Conical Cartridge Ø 0.5 mm S2 Ø 0.020 in		Package 0603 QFP, IC	Stations: CDB, CDEB, DI, DDE, DME Tools: T245, T245G, T245P, T245N
	C245001	Conical Cartridge Ø 0.6 mm Ø 0.024 in		Package 0603 QFP, IC	Stations: CDB, CDEB, DI, DDE, DME Tools: T245, T245G, T245P, T245N
	C245201	Conical Cartridge Ø 0.6 mm L Ø 0.024 in		Package 0603 QFP, IC	Stations: CDB, CDEB, DI, DDE, DME Tools: T245, T245G, T245P, T245N
	C245937	Conical Cartridge Ø 0.6 mm HT Ø 0.024 in		Package 0603 QFP, IC	Stations: CDB, CDEB, DI, DDE, DME Tools: T245, T245G, T245P, T245N

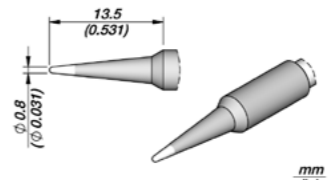
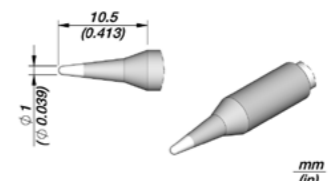
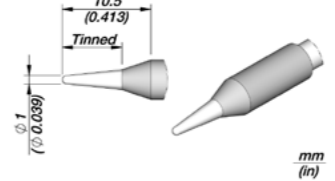
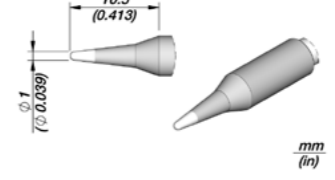
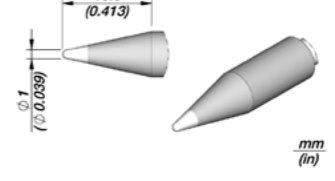
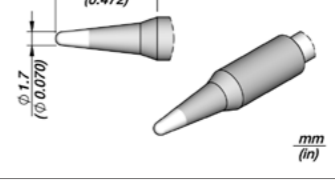
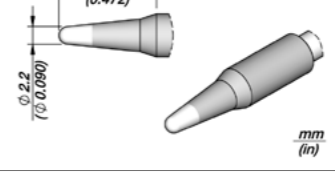
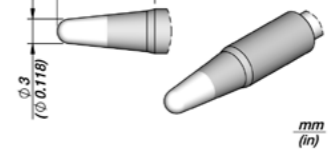

C245 Cartridge Range for T245 General Purpose Handles

	Ref.	Description	Image and dimensions	Suggested components	Compatible with
	C245957	Conical Cartridge Ø 0.8 mm Ø 0.031 in			Through-hole Stations: CDB, CDEB, DI, DDE, DME Tools: T245, T245G, T245P, T245N
	C245903	Conical Cartridge Ø 1 mm S1 Ø 0.040 in			General use Stations: CDB, CDEB, DI, DDE, DME Tools: T245, T245G, T245P, T245N
	C245041	Conical Cartridge Ø 1 mm S2 Ø 0.040 in			General use Tip with an extra tinned surface Stations: CDB, CDEB, DI, DDE, DME Tools: T245, T245G, T245P, T245N
	C245803	Conical Cartridge Ø 1 mm L Ø 0.040 in			General use Stations: CDB, CDEB, DI, DDE, DME Tools: T245, T245G, T245P, T245N
	C245403	Conical Cartridge Ø 1 HT mm Ø 0.040 in			General use Stations: CDB, CDEB, DI, DDE, DME Tools: T245, T245G, T245P, T245N
	C245943	Conical Cartridge Ø 1.7 mm Ø 0.070 in			General use Stations: CDB, CDEB, DI, DDE, DME Tools: T245, T245G, T245P, T245N
	C245933	Conical Cartridge Ø 2.2 mm Ø 0.090 in			General use Stations: CDB, CDEB, DI, DDE, DME Tools: T245, T245G, T245P, T245N
	C245107	Conical Cartridge Ø 3 mm HT Ø 0.118 in			General use Stations: CDB, CDEB, DI, DDE, DME Tools: T245, T245G, T245P, T245N

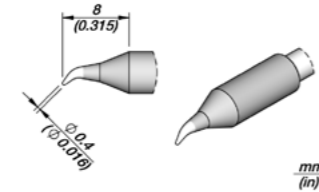
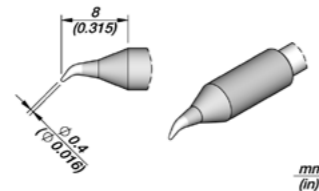
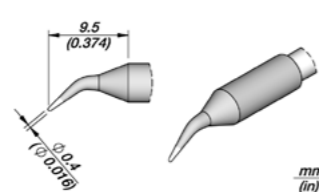
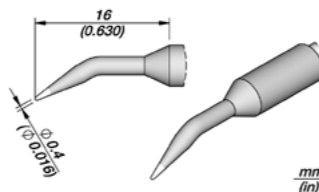
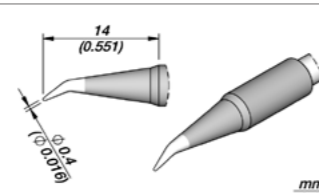
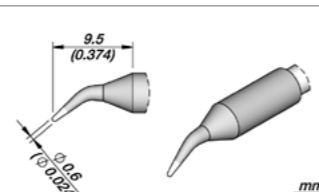
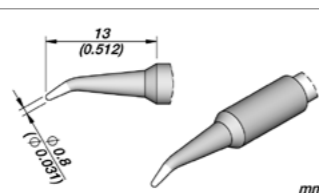
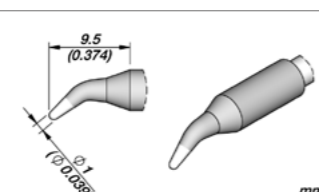
C245 Cartridge Range for T245 General Purpose Handles

	Ref.	Description	Image and dimensions	Suggested components	Compatible with
	C245034	Conical Bent Cartridge Ø 0.4 mm S1 Ø 0.016 in		Package 0201, 0402 Fine pitch 0.65 mm QFP, IC	Stations: CDB, CDEB, DI, DDE, DME Tools: T245, T245G, T245P, T245N
	C245234	Conical Bent Cartridge Ø 0.4 mm S1 L Ø 0.016 in		Package 0201, 0402 Fine pitch 0.65 mm QFP, IC	Stations: CDB, CDEB, DI, DDE, DME Tools: T245, T245G, T245P, T245N
	C245029	Conical Bent Cartridge Ø 0.4 mm S2 Ø 0.016 in		Package 0201, 0402 Fine pitch 0.65 mm QFP, IC	Stations: CDB, CDEB, DI, DDE, DME Tools: T245, T245G, T245P, T245N
	C245126	Conical Bent Cartridge Ø 0.4 mm S3 Ø 0.016 in		Package 0201, 0402 Fine pitch 0.65 mm QFP, IC	Stations: CDB, CDEB, DI, DDE, DME Tools: T245, T245G, T245P, T245N
	C245786	Conical Bent Cartridge Ø 0.4 mm S4 Ø 0.016 in		Package 0201, 0402 Fine pitch 0.65 mm QFP, IC	Stations: CDB, CDEB, DI, DDE, DME Tools: T245, T245G, T245P, T245N
	C245929	Conical Bent Cartridge Ø 0.6 mm Ø 0.024 in		Package 0603 QFP, IC	Stations: CDB, CDEB, DI, DDE, DME Tools: T245, T245G, T245P, T245N
	C245935	Conical Bent Cartridge Ø 0.8 mm Ø 0.031 in		Through-hole	Stations: CDB, CDEB, DI, DDE, DME Tools: T245, T245G, T245P, T245N
	C245904	Conical Bent Cartridge Ø 1 mm Ø 0.039 in		General use	Stations: CDB, CDEB, DI, DDE, DME Tools: T245, T245G, T245P, T245N

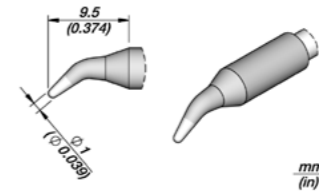
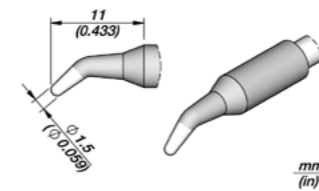
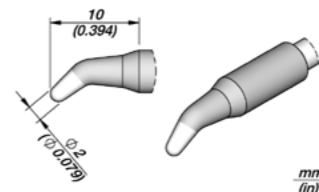
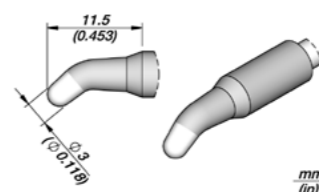
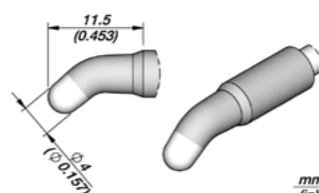
C245 Cartridge Range for T245 General Purpose Handles

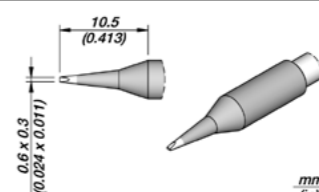
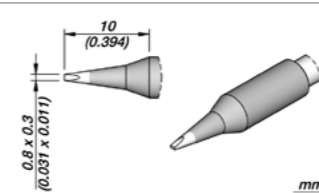
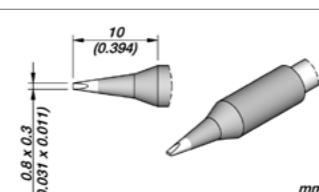
	Ref.	Description	Image and dimensions	Suggested components	Compatible with
	C245804	Conical Bent Cartridge Ø 1 mm L Ø 0.039 in		General use	Stations: CDB, CDEB, DI, DDE, DME Tools: T245, T245G, T245P, T245N
	C245259	Conical Bent Cartridge Ø 1.5 mm Ø 0.059 in		General use	Stations: CDB, CDEB, DI, DDE, DME Tools: T245, T245G, T245P, T245N
	C245260	Conical Bent Cartridge Ø 2 mm HT Ø 0.079 in		General use	Stations: CDB, CDEB, DI, DDE, DME Tools: T245, T245G, T245P, T245N
	C245627	Conical Bent Cartridge Ø 3 mm Ø 0.118 in		General use	Stations: CDB, CDEB, DI, DDE, DME Tools: T245, T245G, T245P, T245N
	C245628	Conical Bent Cartridge Ø 4 mm HT Ø 0.157 in		General use	Stations: CDB, CDEB, DI, DDE, DME Tools: T245, T245G, T245P, T245N
	C245731	Chisel Cartridge 0.6 x 0.3 mm 0.024 x 0.011 in		Package 0603	Stations: CDB, CDEB, DI, DDE, DME Tools: T245, T245G, T245P, T245N
	C245773	Chisel Cartridge 0.8 x 0.3 mm 0.031 x 0.011 in		Package 0805 Through-hole	Stations: CDB, CDEB, DI, DDE, DME Tools: T245, T245G, T245P, T245N
	C245673	Chisel Cartridge 0.8 x 0.3 mm L 0.031 x 0.011 in		Package 0805 Through-hole	Stations: CDB, CDEB, DI, DDE, DME Tools: T245, T245G, T245P, T245N

C245 Cartridge Range for T245 General Purpose Handles

Ref.	Description	Image and dimensions	Suggested components	Compatible with
C245742	Chisel Cartridge 0.8 x 0.6 mm HT 0.032 x 0.024 in		Package 0805 Through-hole	Stations: CDB, CDEB, DI, DDE, DME Tools: T245, T245G, T245P, T245N
C245774	Chisel Cartridge 1.2 x 0.3 mm 0.047 x 0.012 in		General use	Stations: CDB, CDEB, DI, DDE, DME Tools: T245, T245G, T245P, T245N
C245906	Chisel Cartridge 1.2 x 0.7 mm 0.047 x 0.027 in		General use	Stations: CDB, CDEB, DI, DDE, DME Tools: T245, T245G, T245P, T245N
C245806	Chisel Cartridge 1.2 x 0.7 mm L 0.047 x 0.028 in		General use	Stations: CDB, CDEB, DI, DDE, DME Tools: T245, T245G, T245P, T245N
C245406	Chisel Cartridge 1.2 x 0.7 mm HT 0.047 x 0.028 in		General use	Stations: CDB, CDEB, DI, DDE, DME Tools: T245, T245G, T245P, T245N
C245768	Chisel Cartridge 1.5 x 0.3 mm 0.059 x 0.012 in		General use	Stations: CDB, CDEB, DI, DDE, DME Tools: T245, T245G, T245P, T245N
C245944	Chisel Cartridge 1.8 x 0.8 mm 0.070 x 0.031 in		General use	Stations: CDB, CDEB, DI, DDE, DME Tools: T245, T245G, T245P, T245N
C245844	Chisel Cartridge 1.8 x 0.8 mm L 0.071 x 0.031 in		General use	Stations: CDB, CDEB, DI, DDE, DME Tools: T245, T245G, T245P, T245N



C245 Cartridge Range for T245 General Purpose Handles

Ref.	Description	Image and dimensions	Suggested components	Compatible with
C245907	Chisel Cartridge 2.2 x 1 mm 0.087 x 0.039 in		General use	Stations: CDB, CDEB, DI, DDE, DME Tools: T245, T245G, T245P, T245N
C245807	Chisel Cartridge 2.2 x 1 mm L 0.087 x 0.039 in		General use	Stations: CDB, CDEB, DI, DDE, DME Tools: T245, T245G, T245P, T245N
C245407	Chisel Cartridge 2.2 x 1 mm HT 0.087 x 0.039 in		General use	Stations: CDB, CDEB, DI, DDE, DME Tools: T245, T245G, T245P, T245N
C245770	Chisel Cartridge 2.4 x 0.3 mm 0.094 x 0.012 in		General use	Stations: CDB, CDEB, DI, DDE, DME Tools: T245, T245G, T245P, T245N
C245759	Chisel Cartridge 2.4 x 0.5 mm HT 0.094 x 0.019 in		General use	Stations: CDB, CDEB, DI, DDE, DME Tools: T245, T245G, T245P, T245N
C245741	Chisel Cartridge 2.4 x 0.6 mm HT 0.095 x 0.024 in		General use	Stations: CDB, CDEB, DI, DDE, DME Tools: T245, T245G, T245P, T245N
C245729	Chisel Cartridge 2.7 x 1 mm 0.106 x 0.039 in		General use	Stations: CDB, CDEB, DI, DDE, DME Tools: T245, T245G, T245P, T245N
C245061	Chisel Cartridge 3 x 1 mm 0.118 x 0.039 in		General use	Stations: CDB, CDEB, DI, DDE, DME Tools: T245, T245G, T245P, T245N

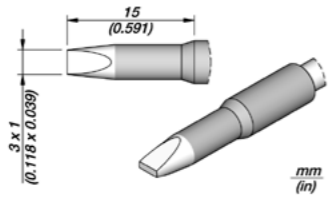
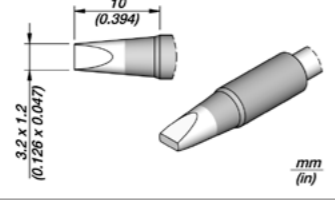
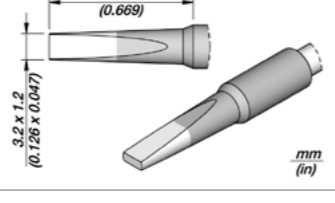
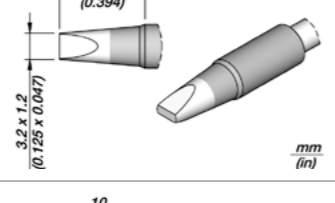
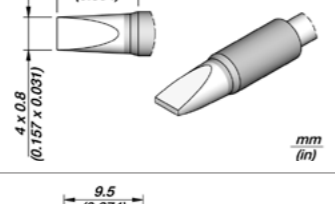
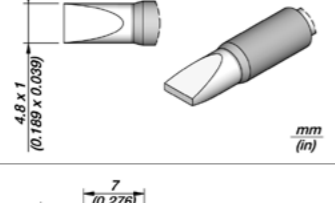
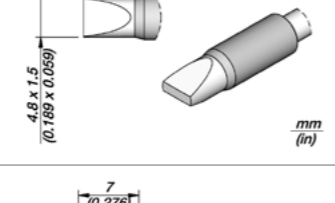
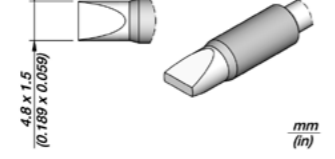

C245 Cartridge Range for T245 General Purpose Handles

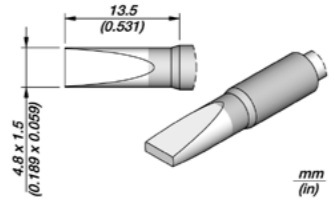
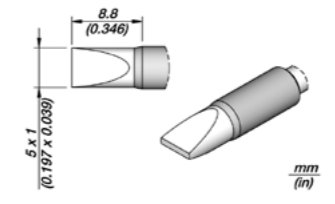
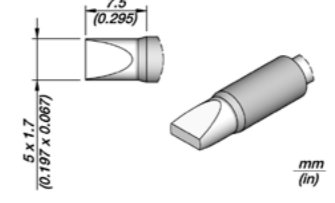
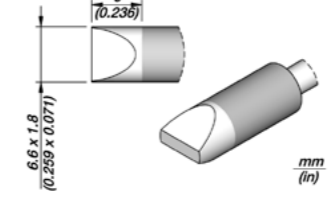
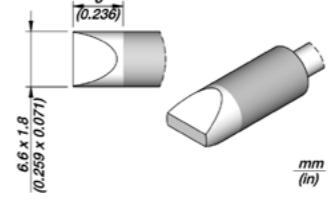
	Ref.	Description	Image and dimensions	Suggested components	Compatible with
	C245261	Chisel Cartridge 3 x 1 mm L 0.118 x 0.039 in		General use	Stations: CDB, CDEB, DI, DDE, DME Tools: T245, T245G, T245P, T245N
	C245911	Chisel Cartridge 3.2 x 1.2 mm 0.126 x 0.047 in		General use	Stations: CDB, CDEB, DI, DDE, DME Tools: T245, T245G, T245P, T245N
	C245775	Chisel Cartridge 3.2 x 1.2 mm S1 0.126 x 0.047 in		General use	Stations: CDB, CDEB, DI, DDE, DME Tools: T245, T245G, T245P, T245N
	C245811	Chisel Cartridge 3.2 x 1.2 mm L 0.125 x 0.047 in		General use	Stations: CDB, CDEB, DI, DDE, DME Tools: T245, T245G, T245P, T245N
	C245755	Chisel Cartridge 4 x 0.8 mm HT 0.157 x 0.031 in		General use	Stations: CDB, CDEB, DI, DDE, DME Tools: T245, T245G, T245P, T245N
	C245756	Chisel Cartridge 4.8 x 1 mm HT 0.189 x 0.374 in		General use	Stations: CDB, CDEB, DI, DDE, DME Tools: T245, T245G, T245P, T245N
	C245908	Chisel Cartridge 4.8 x 1.5 mm HT S1 0.189 x 0.059 in		General use	Stations: CDB, CDEB, DI, DDE, DME Tools: T245, T245G, T245P, T245N
	C245808	Chisel Cartridge 4.8 x 1.5 mm HT L 0.189 x 0.059 in		General use	Stations: CDB, CDEB, DI, DDE, DME Tools: T245, T245G, T245P, T245N

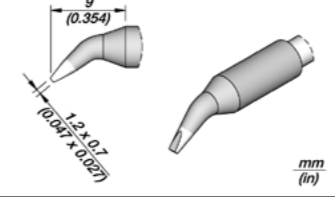
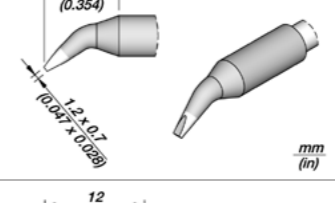
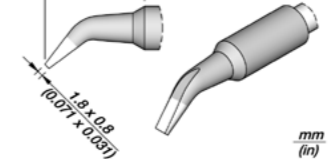
C245 Cartridge Range for T245 General Purpose Handles

	Ref.	Description	Image and dimensions	Suggested components	Compatible with
	C245708	Chisel Cartridge 4.8 x 1.5 mm HT S2 0.189 x 0.059 in		General use	Stations: CDB, CDEB, DI, DDE, DME Tools: T245, T245G, T245P, T245N
	C245967	Chisel Cartridge 5 x 1 mm HT 0.197 x 0.039 in		General use	Stations: CDB, CDEB, DI, DDE, DME Tools: T245, T245G, T245P, T245N
	C245069	Chisel Cartridge 5 x 1.7 mm HT 0.197 x 0.067 in		General use	Stations: CDB, CDEB, DI, DDE, DME Tools: T245, T245G, T245P, T245N
	C245966	Chisel Cartridge 6.6 x 1.8 mm HT 0.259 x 0.071 in		General use	Stations: CDB, CDEB, DI, DDE, DME Tools: T245, T245G, T245P, T245N
	C245866	Chisel Cartridge 6.6 x 1.8 mm HT L 0.259 x 0.071 in		General use	Stations: CDB, CDEB, DI, DDE, DME Tools: T245, T245G, T245P, T245N
	C245962	Chisel Bent Cartridge 1.2 x 0.7 mm 0.047 x 0.027 in		General use	Stations: CDB, CDEB, DI, DDE, DME Tools: T245, T245G, T245P, T245N
	C245862	Chisel Bent Cartridge 1.2 x 0.7 mm L 0.047 x 0.028 in		General use	Stations: CDB, CDEB, DI, DDE, DME Tools: T245, T245G, T245P, T245N
	C245963	Chisel Bent Cartridge 1.8 x 0.8 mm 0.071 x 0.031 in		General use	Stations: CDB, CDEB, DI, DDE, DME Tools: T245, T245G, T245P, T245N

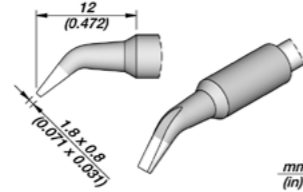
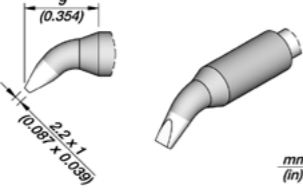
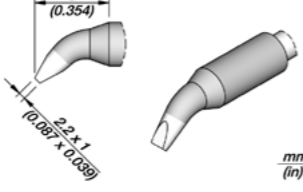
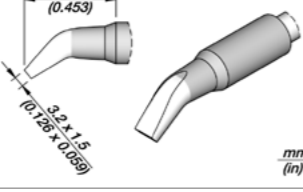
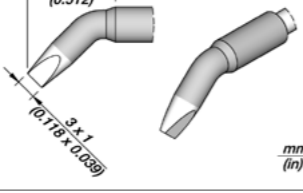
C245 Cartridge Range for T245 General Purpose Handles

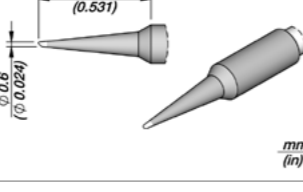
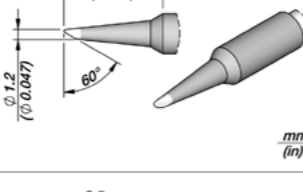
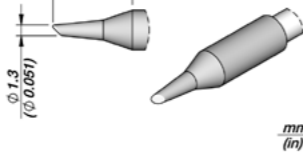
	Ref.	Description	Image and dimensions	Suggested components	Compatible with
	C245863	Chisel Bent Cartridge 1.8 x 0.8 mm L 0.071 x 0.031 in		General use	Stations: CDB, CDEB, DI, DDE, DME Tools: T245, T245G, T245P, T245N
	C245946	Chisel Bent Cartridge 2.2 x 1 mm 0.087 x 0.039 in		General use	Stations: CDB, CDEB, DI, DDE, DME Tools: T245, T245G, T245P, T245N
	C245846	Chisel Bent Cartridge 2.2 x 1 mm L 0.087 x 0.039 in		General use	Stations: CDB, CDEB, DI, DDE, DME Tools: T245, T245G, T245P, T245N
	C245732	Chisel Bent Cartridge 3.2 x 1.5 mm 0.126 x 0.059 in		General use	Stations: CDB, CDEB, DI, DDE, DME Tools: T245, T245G, T245P, T245N
	C245761	Chisel Bent Cartridge 3 x 1 mm 0.118 x 0.039 in		General use	Stations: CDB, CDEB, DI, DDE, DME Tools: T245, T245G, T245P, T245N
	C245747	Bevel Cartridge Ø 0.6 mm Ø 0.024 in		Package 0603 Through-hole	Stations: CDB, CDEB, DI, DDE, DME Tools: T245, T245G, T245P, T245N
	C245710	Bevel Cartridge Ø 1.2 mm Ø 0.047 in		Drag soldering Through-hole	Stations: CDB, CDEB, DI, DDE, DME Tools: T245, T245G, T245P, T245N
	C245064	Bevel Cartridge Ø 1.3 mm Ø 0.051 in		Drag soldering Through-hole Hoof tip with reduced tinned surface, ideal for touch-up	Stations: CDB, CDEB, DI, DDE, DME Tools: T245, T245G, T245P, T245N



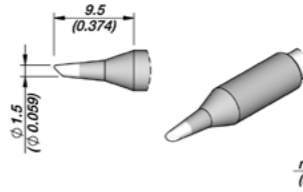
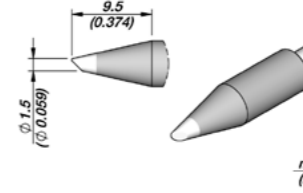
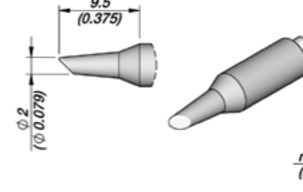
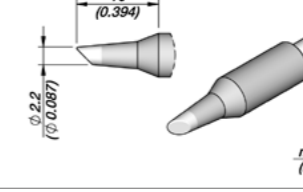
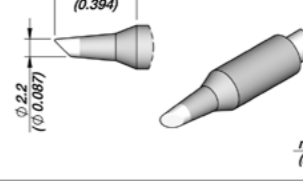
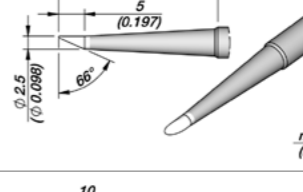
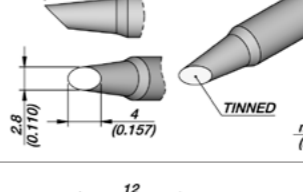
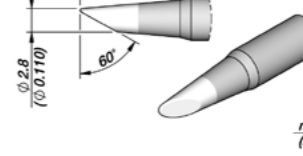

C245 Cartridge Range for T245 General Purpose Handles

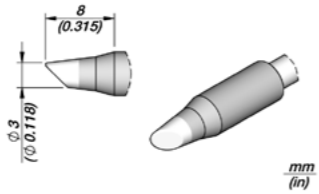
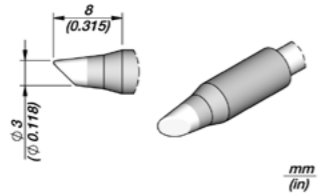
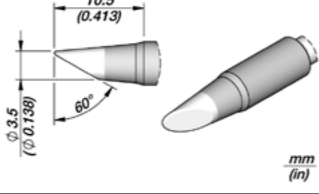
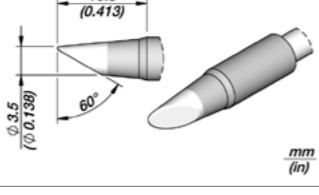
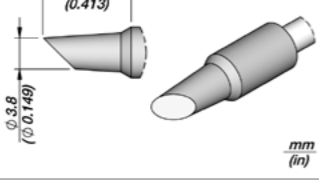
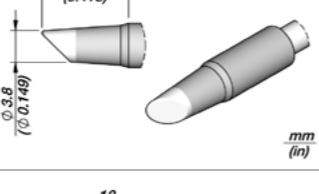
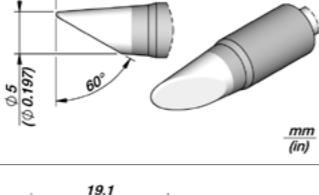
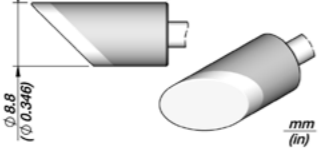
	Ref.	Description	Image and dimensions	Suggested components	Compatible with
	C245905	Bevel Cartridge Ø 1.5 mm Ø 0.059 in		Drag soldering Through-hole	Stations: CDB, CDEB, DI, DDE, DME Tools: T245, T245G, T245P, T245N
	C245405	Bevel Cartridge Ø 1.5 mm HT Ø 0.059 in		Drag soldering Through-hole	Stations: CDB, CDEB, DI, DDE, DME Tools: T245, T245G, T245P, T245N
	C245102	Bevel Cartridge Ø 2 mm Ø 0.079 in		Drag soldering Through-hole Hoof tip with reduced tinned surface, ideal for touch-up	Stations: CDB, CDEB, DI, DDE, DME Tools: T245, T245G, T245P, T245N
	C245945	Bevel Cartridge Ø 2.2 mm Ø 0.087 in		Drag soldering Through-hole	Stations: CDB, CDEB, DI, DDE, DME Tools: T245, T245G, T245P, T245N
	C245845	Bevel Cartridge Ø 2.2 mm L Ø 0.087 in		Drag soldering Through-hole	Stations: CDB, CDEB, DI, DDE, DME Tools: T245, T245G, T245P, T245N
	C245795	Bevel Cartridge Ø 2.5 mm L Ø 0.098 in		Drag soldering Through-hole	Stations: CDB, CDEB, DI, DDE, DME Tools: T245, T245G, T245P, T245N
	C245784	Bevel Cartridge Ø 2.8 mm Ø 0.110 in		Drag soldering Through-hole	Stations: CDB, CDEB, DI, DDE, DME Tools: T245, T245G, T245P, T245N
	C245793	Bevel Cartridge Ø 2.8 mm - 60° Ø 0.110 in - 60°		Drag soldering Through-hole	Stations: CDB, CDEB, DI, DDE, DME Tools: T245, T245G, T245P, T245N

C245 Cartridge Range for T245 General Purpose Handles

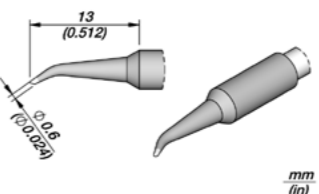
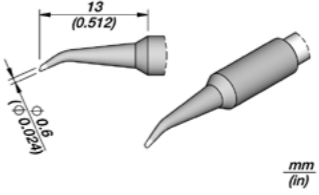
	Ref.	Description	Image and dimensions	Suggested components	Compatible with
	C245912	Bevel Cartridge Ø 3 mm Ø 0.118 in		Drag soldering Through-hole	Stations: CDB, CDEB, DI, DDE, DME Tools: T245, T245G, T245P, T245N
	C245812	Bevel Cartridge Ø 3 mm L Ø 0.118 in		Drag soldering Through-hole	Stations: CDB, CDEB, DI, DDE, DME Tools: T245, T245G, T245P, T245N
	C245056	Bevel Cartridge Ø 3.5 mm HT Ø 0.138 in		Drag soldering Through-hole	Stations: CDB, CDEB, DI, DDE, DME Tools: T245, T245G, T245P, T245N
	C245256	Bevel Cartridge Ø 3.5 mm HT L Ø 0.138 in		Drag soldering Through-hole	Stations: CDB, CDEB, DI, DDE, DME Tools: T245, T245G, T245P, T245N
	C245797	Bevel Cartridge Ø 3.8 mm Ø 0.149 in		Hoof Tip with reduced tinned surface, ideal for touch-up	Stations: CDB, CDEB, DI, DDE, DME Tools: T245, T245G, T245P, T245N
	C245951	Bevel Cartridge Ø 3.8 mm HT Ø 0.149 in		Drag soldering Through-hole	Stations: CDB, CDEB, DI, DDE, DME Tools: T245, T245G, T245P, T245N
	C245766	Bevel Cartridge Ø 5 mm Ø 0.197 in		Wide area	Stations: CDB, CDEB, DI, DDE, DME Tools: T245, T245G, T245P, T245N
	C245301	Bevel Cartridge Ø 8 mm Ø 0.346 in		Wide area	Stations: CDB, CDEB, DI, DDE, DME Tools: T245, T245G, T245P, T245N

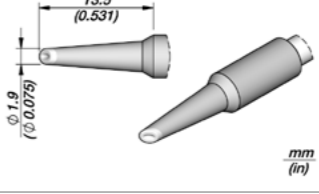
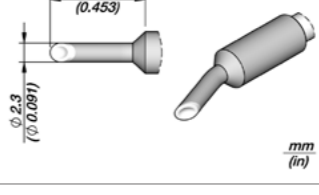
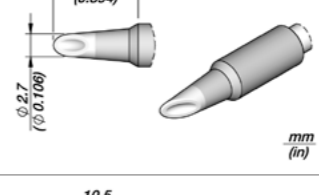
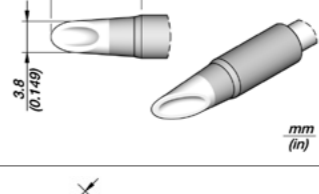
C245 Cartridge Range for T245 General Purpose Handles

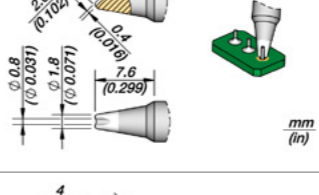
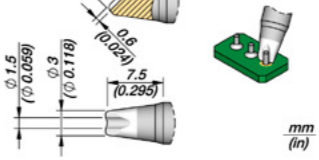
	Ref.	Description	Image and dimensions	Suggested components	Compatible with
	C245748	Bevel Bent Cartridge Ø 0.6 mm S1 Ø 0.024 in		Package 0603 Through-hole	Stations: CDB, CDEB, DI, DDE, DME Tools: T245, T245G, T245P, T245N
	C245749	Bevel Bent Cartridge Ø 0.6 mm S2 Ø 0.024 in		Package 0603 Through-hole	Stations: CDB, CDEB, DI, DDE, DME Tools: T245, T245G, T245P, T245N
	C245965	Spoon Cartridge Ø 1.9 mm Ø 0.075 in		Drag soldering	Stations: CDB, CDEB, DI, DDE, DME Tools: T245, T245G, T245P, T245N
	C245067	Spoon Cartridge Ø 2.3 mm Ø 0.091 in		Drag soldering	Stations: CDB, CDEB, DI, DDE, DME Tools: T245, T245G, T245P, T245N
	C245931	Spoon Cartridge Ø 2.7 mm Ø 0.106 in		Drag soldering	Stations: CDB, CDEB, DI, DDE, DME Tools: T245, T245G, T245P, T245N
	C245938	Spoon Cartridge Ø 3.8 mm Ø 0.149 in		Drag soldering	Stations: CDB, CDEB, DI, DDE, DME Tools: T245, T245G, T245P, T245N
	C245790	Barrel Cartridge Ø 0.8 mm Ø 0.031 in		Through-hole Cable sold/desol	Stations: CDB, CDEB, DI, DDE, DME Tools: T245, T245G, T245P, T245N
	C245785	Barrel Cartridge Ø 1.5 mm Ø 0.059 in		Through-hole Cable sold/desol	Stations: CDB, CDEB, DI, DDE, DME Tools: T245, T245G, T245P, T245N

C245 Cartridge Range for T245 General Purpose Handles

Ref.	Description	Image and dimensions	Suggested components	Compatible with
C245763	Barrel Cartridge Ø 2.5 mm Ø 0.098 in		Through-hole Cable sold/desol	Stations: CDB, CDEB, DI, DDE, DME Tools: T245, T245G, T245P, T245N
C245760	Barrel Cartridge Ø 3.5 mm Ø 0.138 in		Through-hole Cable sold/desol	Stations: CDB, CDEB, DI, DDE, DME Tools: T245, T245G, T245P, T245N
C245762	Round Connector Cartridge R. 4.5 mm R. 0.177 in		Cable sold/desol	Stations: CDB, CDEB, DI, DDE, DME Tools: T245, T245G, T245P, T245N
C245662	Round Connector Cartridge R. 4.5 mm L R. 0.177 in		Cable sold/desol	Stations: CDB, CDEB, DI, DDE, DME Tools: T245, T245G, T245P, T245N
C245789	Knife Cartridge 3.8 x 0.3 mm 0.150 x 0.012 in		Drag soldering	Stations: CDB, CDEB, DI, DDE, DME Tools: T245, T245G, T245P, T245N
C245939	Knife Cartridge 6.0 x 0.4 mm 0.236 x 0.016 in		Drag soldering	Stations: CDB, CDEB, DI, DDE, DME Tools: T245, T245G, T245P, T245N
C245765	Knife Cartridge 6.0 x 0.4 mm S1 0.236 x 0.016 in		Drag soldering	Stations: CDB, CDEB, DI, DDE, DME Tools: T245, T245G, T245P, T245N
C245955	Knife Cartridge 13 x 0.5 mm 0.512 x 0.020 in		Drag Soldering Connector desoldering	Stations: CDB, CDEB, DI, DDE, DME Tools: T245, T245G, T245P, T245N

C245 Cartridge Range for T245 General Purpose Handles

Ref.	Description	Image and dimensions	Suggested components	Compatible with
C245914	Blade Cartridge 10 mm S1 0.394 in		Pad cleaning Connector desoldering	Stations: CDB, CDEB, DI, DDE, DME Tools: T245, T245G, T245P, T245N
C245752	Blade Cartridge 15 mm 0.591 in		Pad cleaning Connector desoldering	Stations: CDB, CDEB, DI, DDE, DME Tools: T245, T245G, T245P, T245N
C245913	Blade Cartridge 21 mm 0.827 in		Pad cleaning Connector desoldering	Stations: CDB, CDEB, DI, DDE, DME Tools: T245, T245G, T245P, T245N
C245949	Blade Cartridge 32 mm 1.260 in		Pad cleaning Connector desoldering	Stations: CDB, CDEB, DI, DDE, DME Tools: T245, T245G, T245P, T245N
C245776	Blade Cartridge 37 mm 1.457 in		Pad cleaning Connector desoldering	Stations: CDB, CDEB, DI, DDE, DME Tools: T245, T245G, T245P, T245N
C245792	Blade Cartridge 40 mm 1.575 in		Pad cleaning Connector desoldering	Stations: CDB, CDEB, DI, DDE, DME Tools: T245, T245G, T245P, T245N
C245730	Blade Cartridge 10 mm S2 0.394 in		Pad cleaning Connector desoldering	Stations: CDB, CDEB, DI, DDE, DME Tools: T245, T245G, T245P, T245N
C245728	Multipad Blade Cartridge 10.1 mm 0.398 in		Connector sold / desold	Stations: CDB, CDEB, DI, DDE, DME Tools: T245, T245G, T245P, T245N

C245 Cartridge Range for T245 General Purpose Handles

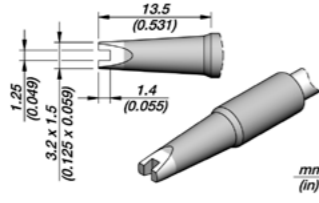
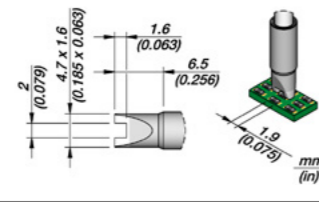
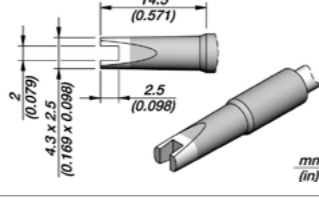
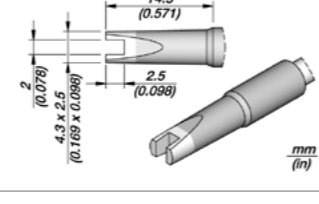
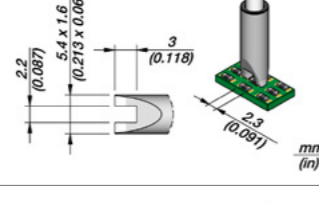
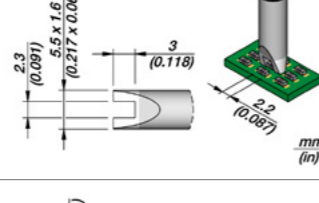
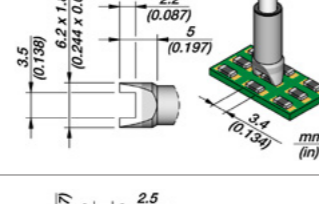
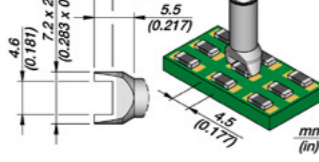
Ref.	Description	Image and dimensions	Suggested components	Compatible with
 C245757	Chip Cartridge 1.25 mm 0.049 in		SMD resistors SMD capacitors	Stations: CDB, CDEB, DI, DDE, DME Tools: T245, T245G, T245P, T245N
C245016	Chip Cartridge 1.9 mm 0.075 in		SMD resistors SMD capacitors	Stations: CDB, CDEB, DI, DDE, DME Tools: T245, T245G, T245P, T245N
C245758	Chip Cartridge 2 mm 0.079 in		SMD resistors SMD capacitors	Stations: CDB, CDEB, DI, DDE, DME Tools: T245, T245G, T245P, T245N
C245658	Chip Cartridge 2.0 mm L 0.078 in		SMD resistors SMD capacitors	Stations: CDB, CDEB, DI, DDE, DME Tools: T245, T245G, T245P, T245N
C245017	Chip Cartridge 2.3 mm S1 0.091 in		SMD resistors SMD capacitors	Stations: CDB, CDEB, DI, DDE, DME Tools: T245, T245G, T245P, T245N
C245150	Chip Cartridge 2.2 mm S2 0.087 in		SMD resistors SMD capacitors	Stations: CDB, CDEB, DI, DDE, DME Tools: T245, T245G, T245P, T245N
C245018	Chip Cartridge 3.4 mm 0.134 in		SMD resistors SMD capacitors	Stations: CDB, CDEB, DI, DDE, DME Tools: T245, T245G, T245P, T245N
C245019	Chip Cartridge 4.5 mm 0.177 in		SMD resistors SMD capacitors	Stations: CDB, CDEB, DI, DDE, DME Tools: T245, T245G, T245P, T245N

C245 Cartridge Range for T245 General Purpose Handles

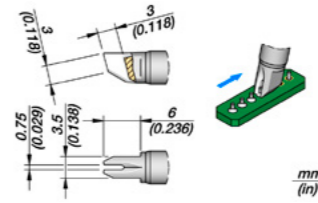
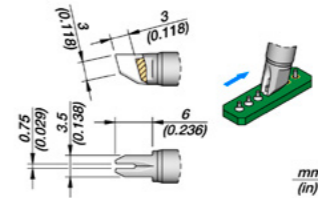
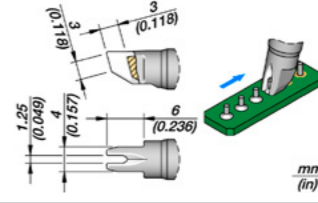
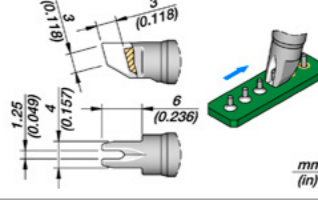
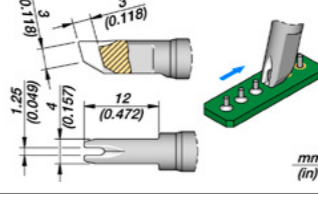
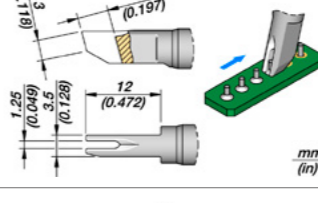
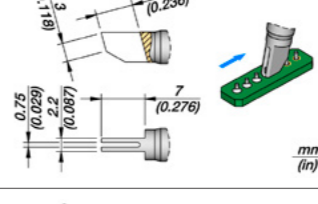
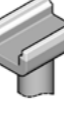
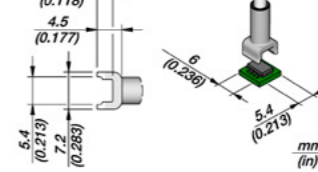
Ref.	Description	Image and dimensions	Suggested components	Compatible with
 C245754	Drag Cartridge 0.75 mm 0.029 in		Drag soldering	Stations: CDB, CDEB, DI, DDE, DME Tools: T245, T245G, T245P, T245N
C245654	Drag Cartridge 0.75 mm L 0.029 in		Drag soldering	Stations: CDB, CDEB, DI, DDE, DME Tools: T245, T245G, T245P, T245N
C245751	Drag Cartridge 1.25 mm 0.049 in		Drag soldering	Stations: CDB, CDEB, DI, DDE, DME Tools: T245, T245G, T245P, T245N
C245651	Drag Cartridge 1.25 mm L 0.049 in		Drag soldering	Stations: CDB, CDEB, DI, DDE, DME Tools: T245, T245G, T245P, T245N
C245667	Drag Cartridge 1.25 mm S1 L 0.049 in		Drag soldering	Stations: CDB, CDEB, DI, DDE, DME Tools: T245, T245G, T245P, T245N
C245669	Drag Cartridge 1.25 mm S2 L 0.049 in		Drag soldering	Stations: CDB, CDEB, DI, DDE, DME Tools: T245, T245G, T245P, T245N
C245796	Drag Cartridge 2.2 x 0.75 mm 0.087 x 0.029 in		Drag soldering	Stations: CDB, CDEB, DI, DDE, DME Tools: T245, T245G, T245P, T245N
 C245220	Tunnel Cartridge 5.4 x 6 mm 0.213 x 0.236 in		Dual in Line IC	Stations: CDB, CDEB, DI, DDE, DME Tools: T245, T245G, T245P, T245N

C245 Cartridge Range for T245 General Purpose Handles

Ref.	Description	Image and dimensions	Suggested components	Compatible with
C245250	Tunnel Cartridge 5.4 x 8 mm 0.213 x 0.315 in		Dual in Line IC	Stations: CDB, CDEB, DI, DDE, DME Tools: T245, T245G, T245P, T245N
C245221	Tunnel Cartridge 5.4 x 10 mm 0.213 x 0.394 in		Dual in Line IC	Stations: CDB, CDEB, DI, DDE, DME Tools: T245, T245G, T245P, T245N
C245303	Tunnel Cartridge 6.5 x 6 mm 0.256 x 0.236 in		Dual in Line IC	Stations: CDB, CDEB, DI, DDE, DME Tools: T245, T245G, T245P, T245N
C245222	Tunnel Cartridge 7.1 x 13 mm 0.279 x 0.512 in		Dual in Line IC	Stations: CDB, CDEB, DI, DDE, DME Tools: T245, T245G, T245P, T245N
C245306	Tunnel Cartridge 9.6 x 10 mm 0.378 x 0.394 in		Dual in Line IC	Stations: CDB, CDEB, DI, DDE, DME Tools: T245, T245G, T245P, T245N
C245305	Tunnel Cartridge 9.6 x 12 mm 0.378 x 0.472 in		Dual in Line IC	Stations: CDB, CDEB, DI, DDE, DME Tools: T245, T245G, T245P, T245N
C245304	Tunnel Cartridge 9.6 x 15 mm 0.378 x 0.591 in		Dual in Line, IC	Stations: CDB, CDEB, DI, DDE, DME Tools: T245, T245G, T245P, T245N
C245215	Tunnel Cartridge 9.6 x 18 mm 0.378 x 0.709 in		Dual in Line IC	Stations: CDB, CDEB, DI, DDE, DME Tools: T245, T245G, T245P, T245N

C245 Cartridge Range for T245 General Purpose Handles

Ref.	Description	Image and dimensions	Suggested components	Compatible with
C245226	Tunnel Cartridge 15.2 x 29 mm 0.598 x 1.142 in		Dual in Line IC	Stations: CDB, CDEB, DI, DDE, DME Tools: T245, T245G, T245P, T245N
C245223	QFP Cartridge 8.5 x 8.5 mm 0.335 x 0.335 in		QFP	Stations: CDB, CDEB, DI, DDE, DME Tools: T245, T245G, T245P, T245N
C245224	QFP Cartridge 12 x 12 mm 0.472 x 0.472 in		QFP	Stations: CDB, CDEB, DI, DDE, DME Tools: T245, T245G, T245P, T245N
C245351	QFP Cartridge 12.3 x 12.3 mm 0.484 x 0.484 in		QFP	Stations: CDB, CDEB, DI, DDE, DME Tools: T245, T245G, T245P, T245N
C245228	QFP Cartridge 12.4 x 15 mm 0.488 x 0.591 in		QFP	Stations: CDB, CDEB, DI, DDE, DME Tools: T245, T245G, T245P, T245N
C245315	QFP Cartridge 15 x 15 mm 0.591 x 0.591 in		QFP	Stations: CDB, CDEB, DI, DDE, DME Tools: T245, T245G, T245P, T245N
C245352	QFP Cartridge 15.4 x 15.4 mm 0.606 x 0.606 in		QFP	Stations: CDB, CDEB, DI, DDE, DME Tools: T245, T245G, T245P, T245N
C245227	QFP Cartridge 17.5 x 17.5 mm 0.689 x 0.689 in		QFP	Stations: CDB, CDEB, DI, DDE, DME Tools: T245, T245G, T245P, T245N





C245 Cartridge Range for T245 General Purpose Handles

Ref.	Description	Image and dimensions	Suggested components	Compatible with
C245344	QFP Cartridge 26 x 26 mm 1.024 x 1.024 in		QFP	Stations: CDB, CDEB, DI, DDE, DME Tools: T245, T245G, T245P, T245N
C245248	Socket Cartridge 11.9 x 14.4 mm 0.469 x 0.571 in		PLCC sockets	Stations: CDB, CDEB, DI, DDE, DME Tools: T245, T245G, T245P, T245N
C245247	Socket Cartridge 17 x 17 mm 0.669 x 0.669 in		PLCC sockets	Stations: CDB, CDEB, DI, DDE, DME Tools: T245, T245G, T245P, T245N
C245053	Heat Staking Cartridge Ø 3.8 mm Ø 0.149 in		Chrome finish, design for plastic rivets	Stations: CDB, CDEB, DI, DDE, DME Tools: T245, T245G, T245P, T245N
C245052	Heat Staking Cartridge Ø 4.9 mm Ø 0.193 in		Chrome finish, design for plastic rivets	Stations: CDB, CDEB, DI, DDE, DME Tools: T245, T245G, T245P, T245N
C245054	Heat Staking Cartridge Ø 6.5 mm Ø 0.256 in		Chrome finish, design for plastic rivets	Stations: CDB, CDEB, DI, DDE, DME Tools: T245, T245G, T245P, T245N
C245798	Heat Staking Cartridge Ø 8 mm Ø 0.315 in		Chrome finish, design for plastic rivets	Stations: CDB, CDEB, DI, DDE, DME Tools: T245, T245G, T245P, T245N
C245791	Heat Staking Cartridge Ø 9.8 mm Ø 0.386 in		Chrome finish, design for plastic rivets	Stations: CDB, CDEB, DI, DDE, DME Tools: T245, T245G, T245P, T245N

C245 Cartridge Range for T245 General Purpose Handles

Ref.	Description	Image and dimensions	Suggested components	Compatible with
C245143	Double Heat Staking Cartridge Ø 1.8 mm Ø 0.071 in		Chrome finish, design for plastic rivets	Stations: CDB, CDEB, DI, DDE, DME Tools: T245, T245G, T245P, T245N
C245163	Hollow Heat Staking Cartridge Ø 2.5 mm Ø 0.098 in		Chrome finish, design for plastic rivets	Stations: CDB, CDEB, DI, DDE, DME Tools: T245, T245G, T245P, T245N
C245166	Plastics Inox. Cartridge Ø 1.7 mm Ø 0.067 in		Plastics	Stations: CDB, CDEB, DI, DDE, DME Tools: T245, T245G, T245P, T245N
C245167	Thermal Hole-Punch Cartridge for Plastic Ø 2.1 mm Ø 0.083 in		Plastics	Stations: CDB, CDEB, DI, DDE, DME Tools: T245, T245G, T245P, T245N
C245168	Thermal Hole-Punch Cartridge for Plastic Ø 3.1 mm Ø 0.122 in		Plastics	Stations: CDB, CDEB, DI, DDE, DME Tools: T245, T245G, T245P, T245N
C245688	Heat Staking Bend Cartridge Ø 3.2 mm Ø 0.125 in		Plastics	Stations: CDB, CDEB, DI, DDE, DME Tools: T245, T245G, T245P, T245N
C245312	Heat Staking Cartridge Ø 3.2 mm Ø 0.126 in		Plastics	Stations: CDB, CDEB, DI, DDE, DME Tools: T245, T245G, T245P, T245N
C245313	Cartridge for Plastics Ø 4.1 mm Ø 0.161 in		Plastics	Stations: CDB, CDEB, DI, DDE, DME Tools: T245, T245G, T245P, T245N
C245123	Cartridge for Plastics 4 x 4 mm 0.157 in		Plastics	Stations: CDB, CDEB, DI, DDE, DME Tools: T245, T245G, T245P, T245N

C245 Cartridge Range for T245 General Purpose Handles

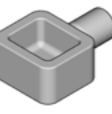

	Ref.	Description	Image and dimensions	Suggested components	Compatible with
	C245124	Cartridge for Plastics 4.25 x 2 mm 0.167 x 0.079 in		Plastics	Stations: CDB, CDEB, DI, DDE, DME Tools: T245, T245G, T245P, T245N
	C245311	Cartridge for Plastics 20 x 6 mm 0.787 x 0.256 in		Plastics	Stations: CDB, CDEB, DI, DDE, DME Tools: T245, T245G, T245P, T245N
	C245109	Conformal Coating Removal Cartridge 4.3 x 0.1 mm 0.169 x 0.004 in		Remove underfill encapsulants	Stations: CDB, CDEB, DI, DDE, DME Tools: T245, T245G, T245P, T245N
	C245138	Cutter Cartridge 12 mm 0.472 in		Plastic Rubber cutter	Stations: CDB, CDEB, DI, DDE, DME Tools: T245, T245G, T245P, T245N
	C245121	Cutter Cartridge 13 mm 0.512 in		Plastic Rubber cutter	Stations: CDB, CDEB, DI, DDE, DME Tools: T245, T245G, T245P, T245N
	C245119	Conical Teflon Cartridge Ø 1 mm Ø 0.039 in		Plastics	Stations: CDB, CDEB, DI, DDE, DME Tools: T245, T245G, T245P, T245N
	C245116	Pin/Connector Cartridge R. 1 mm R. 0.039 in		Through-hole Coaxial connector	Stations: CDB, CDEB, DI, DDE, DME Tools: T245, T245G, T245P, T245N
	C245122	Pin/Connector Cartridge 1.5 x 0.5 mm 0.059 x 0.019 in		Cylinder parts	Stations: CDB, CDEB, DI, DDE, DME Tools: T245, T245G, T245P, T245N
	C245764	Fine Pitch Cartridge Ø 0.5 mm Ø 0.019 in		Package 0603 QFP, IC Fine pitch	Stations: CDB, CDEB, DI, DDE, DME Tools: T245, T245G, T245P, T245N

C245 Cartridge Range for T245 General Purpose Handles



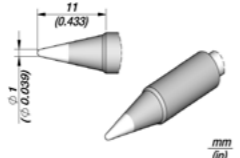

	Ref.	Description	Image and dimensions	Suggested components	Compatible with
	C245771	Bent Cartridge 1 x 0.1 mm 0.039 x 0.004 in		Cable soldering to connector Fine pitch	Stations: CDB, CDEB, DI, DDE, DME Tools: T245, T245G, T245P, T245N
	C245117	Flat Cartridge Ø 1.4 mm Ø 0.055 in		Through-hole	Stations: CDB, CDEB, DI, DDE, DME Tools: T245, T245G, T245P, T245N
	C245118	Pin/Wire Cartridge 0.4 mm 0.016 in		Through-hole Wire tinning	Stations: CDB, CDEB, DI, DDE, DME Tools: T245, T245G, T245P, T245N
	C245268	Pin/Wire Cartridge 1.5 mm 0.059 in		Through-hole	Stations: CDB, CDEB, DI, DDE, DME Tools: T245, T245G, T245P, T245N
	C245136	Micro Stick Switch Cartridge 7.1 x 6.5 mm 0.279 x 0.256 in		Micro Stick desoldering	Stations: CDB, CDEB, DI, DDE, DME Tools: T245, T245G, T245P, T245N
	C245772	Nickel Cartridge Ø 1.4 x 0.7 mm S1 Ø 0.055 x 0.028 in		HMP Soldering	Stations: CDB, CDEB, DI, DDE, DME Tools: T245, T245G, T245P, T245N
	C245009	S-Lead Cartridge 4.4 x 1.8 mm 0.177 x 0.071 in		Drag Soldering	Stations: CDB, CDEB, DI, DDE, DME Tools: T245, T245G, T245P, T245N
	C245010	J-Lead Cartridge 4.4 x 1.8 mm 0.177 x 0.071 in		Drag Soldering J-lead	Stations: CDB, CDEB, DI, DDE, DME Tools: T245, T245G, T245P, T245N
	C245SP01	Solder Pot Cartridge 15 x 18 mm 0.591 x 0.709 in		Tinning wires, Desoldering and Through-hole Multipin components	Stations: CDB, CDEB, DI, DDE, DME Tools: T245, T245G, T245P, T245N

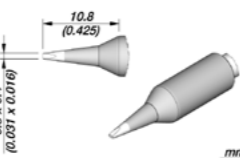
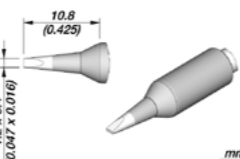
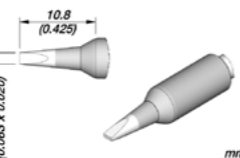
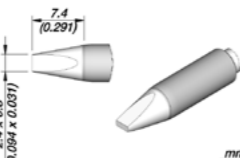
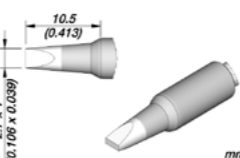
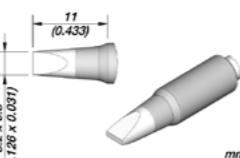
C245E Extended Tip Life Cartridge Range
for T245 General Purpose Handles

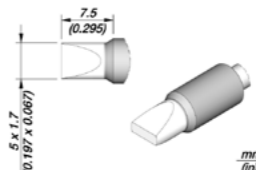
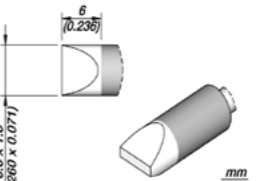

	Ref.	Description	Image and dimensions	Suggested components	Compatible with
	C245736E	Conical Cartridge Ø 1 mm Ø 0.039 in		General use	Stations: CDB, CDEB, DI, DDE, DME Tools: T245, T245G, T245P, T245N
	C245159E	Chisel Cartridge 0.8 x 0.4 mm 0.031 x 0.016 in		General use	Stations: CDB, CDEB, DI, DDE, DME Tools: T245, T245G, T245P, T245N
	C245158E	Chisel Cartridge 1.2 x 0.4 mm 0.047 x 0.016 in		General use	Stations: CDB, CDEB, DI, DDE, DME Tools: T245, T245G, T245P, T245N
	C245160E	Chisel Cartridge 1.6 x 0.5 mm 0.063 x 0.020 in		General use	Stations: CDB, CDEB, DI, DDE, DME Tools: T245, T245G, T245P, T245N
	C245155E	Chisel Cartridge 2.4 x 0.8 mm 0.094 x 0.031 in		General use	Stations: CDB, CDEB, DI, DDE, DME Tools: T245, T245G, T245P, T245N
	C245735E	Chisel Cartridge 2.7 x 1 mm 0.106 x 0.039 in		General use	Stations: CDB, CDEB, DI, DDE, DME Tools: T245, T245G, T245P, T245N
	C245161E	Chisel Cartridge 3.2 x 0.8 mm 0.126 x 0.031 in		General use	Stations: CDB, CDEB, DI, DDE, DME Tools: T245, T245G, T245P, T245N

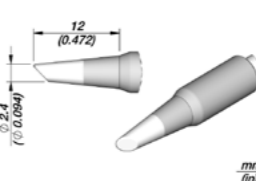
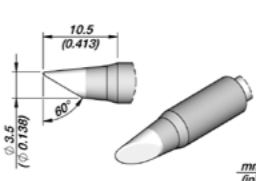

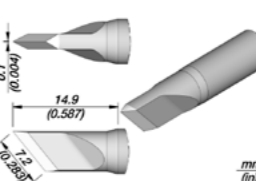
C245E Extended Tip Life Cartridge Range for T245 General Purpose Handles

	Ref.	Description	Image and dimensions	Suggested components	Compatible with
	C245070E	Chisel Cartridge 5 x 1.7 mm 0.197 x 0.067 in		General use	Stations: CDB, CDEB, DI, DDE, DME Tools: T245, T245G, T245P, T245N
	C245968E	Chisel Cartridge 6.6 x 1.8 mm 0.260 x 0.071 in		General use	Stations: CDB, CDEB, DI, DDE, DME Tools: T245, T245G, T245P, T245N
	C245156E	Bevel Cartridge Ø 2.4 mm Ø 0.094 in		Drag soldering Through-hole	Stations: CDB, CDEB, DI, DDE, DME Tools: T245, T245G, T245P, T245N
	C245354E	Bevel Cartridge Ø 3.5 mm L Ø 0.138 in		Drag soldering Through-hole	Stations: CDB, CDEB, DI, DDE, DME Tools: T245, T245G, T245P, T245N
	C245157E	Knife Cartridge 7.2 mm 0.283 in		Drag soldering Through-hole	Stations: CDB, CDEB, DI, DDE, DME Tools: T245, T245G, T245P, T245N

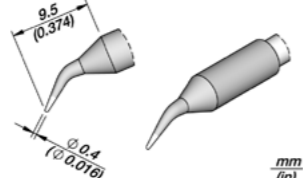
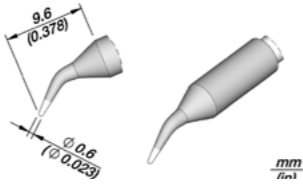
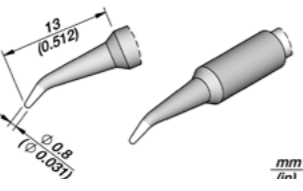
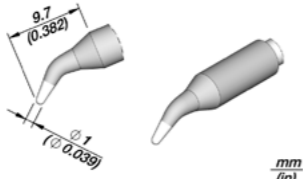
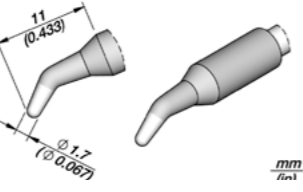
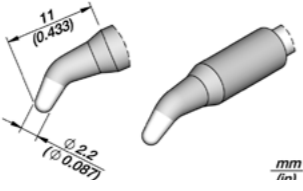

C250 Cartridge Range

for **ALE250** Auto-Feed Iron and **AP250** Solder Feed Iron

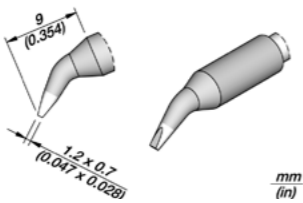

	Ref.	Description	Image and dimensions	Suggested components	Compatible with
	C250420	Conical Bent Cartridge Ø 0.4 mm Ø 0.016 in		Package 0201, 0402 Fine pitch 0.65 mm QFP, IC	Stations: ALE, CA Tools: ALE250, AP250
	C250401	Conical Bent Cartridge Ø 0.6 mm Ø 0.023 in		Package 0603 QFP, IC	Stations: ALE, CA Tools: ALE250, AP250
	C250402	Conical Bent Cartridge Ø 0.8 mm Ø 0.031 in		General use	Stations: ALE, CA Tools: ALE250, AP250
	C250403	Conical Bent Cartridge Ø 1 mm Ø 0.039 in		General use	Stations: ALE, CA Tools: ALE250, AP250
	C250409	Conical Bent Cartridge Ø 1.7 mm Ø 0.067 in		General use	Stations: ALE, CA Tools: ALE250, AP250
	C250410	Conical Bent Cartridge Ø 2.2 mm Ø 0.087 in		General use	Stations: ALE, CA Tools: ALE250, AP250
	C250404	Chisel Bent Cartridge 1.2 x 0.7 mm 0.047 x 0.028 in		General use	Stations: ALE, CA Tools: ALE250, AP250

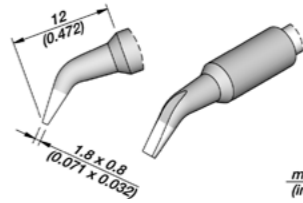
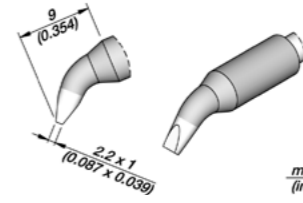
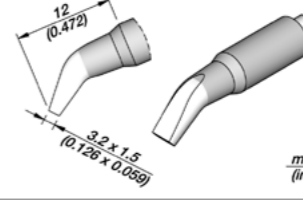
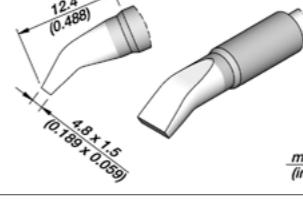
C250 Cartridge Range for **ALE250** Auto-Feed Iron and **AP250** Solder Feed Iron

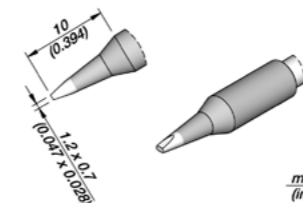
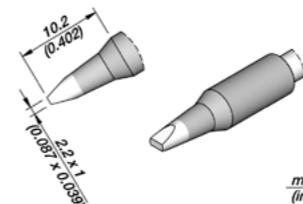
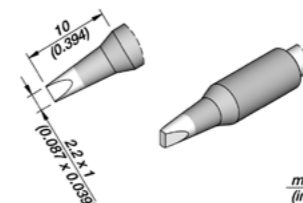
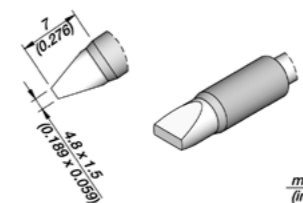
	Ref.	Description	Image and dimensions	Suggested components	Compatible with
	C250405	Chisel Bent Cartridge 1.8 x 0.8 mm 0.071 x 0.032 in		General use	Stations: ALE, CA Tools: ALE250, AP250
	C250406	Chisel Bent Cartridge 2.2 x 1 mm 0.087 x 0.039 in		General use	Stations: ALE, CA Tools: ALE250, AP250
	C250418	Chisel Bent Cartridge 3.2 x 1.5 mm 0.126 x 0.059 in		General use	Stations: ALE, CA Tools: ALE250, AP250
	C250412	Chisel Bent Cartridge 4.8 x 1.5 mm 0.189 x 0.059 in		General use	Stations: ALE, CA Tools: ALE250, AP250
	C250407	Chisel Cartridge 1.2 x 0.7 mm 0.047 x 0.028 in		General use	Stations: ALE, CA Tools: ALE250, AP250
	C250408	Chisel Cartridge 2.2 x 1 mm S1 0.087 x 0.039 in		General use	Stations: ALE, CA Tools: ALE250, AP250
	C250413	Chisel Cartridge 2.2 x 1 mm S2 0.087 x 0.039 in		General use	Stations: ALE, CA Tools: ALE250, AP250
	C250411	Chisel Cartridge 4.8 x 1.5 mm 0.189 x 0.059 in		General use	Stations: ALE, CA Tools: ALE250, AP250

C250 Cartridge Range for ALE250 Auto-Feed Iron and AP250 Solder Feed Iron

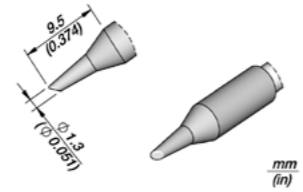
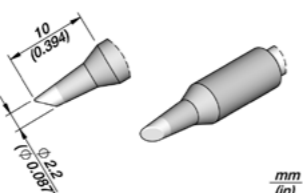
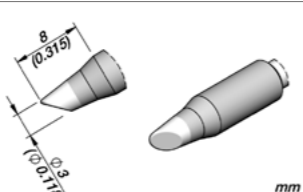
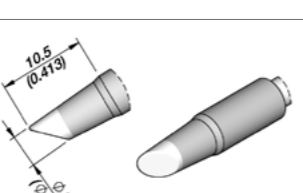

Ref.	Description	Image and dimensions	Suggested components	Compatible with
C250426	Bevel Cartridge Ø 1.3 mm Ø 0.051 in		Drag soldering Through-hole	Stations: ALE, CA Tools: ALE250, AP250
C250414	Bevel Cartridge Ø 2.2 mm Ø 0.087 in		Drag soldering Through-hole	Stations: ALE, CA Tools: ALE250, AP250
C250424	Bevel Cartridge Ø 3 mm Ø 0.118 in		Drag soldering Through-hole	Stations: ALE, CA Tools: ALE250, AP250
C250415	Bevel Cartridge Ø 3.8 mm Ø 0.149 in		Drag soldering Through-hole	Stations: ALE, CA Tools: ALE250, AP250

C420 Cartridge Range
for AT420 and HT420 Thermal Tweezers

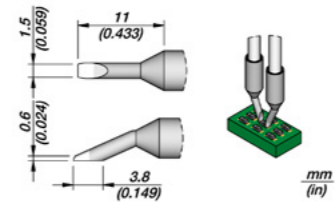
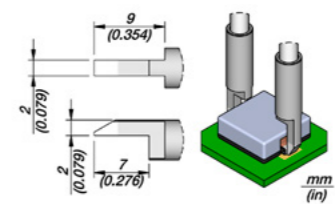
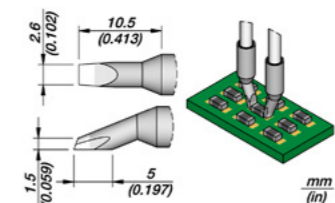
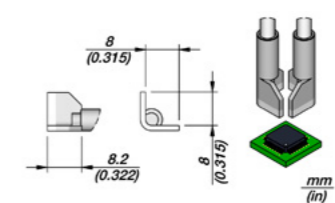
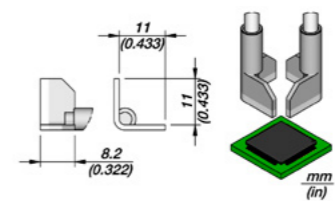
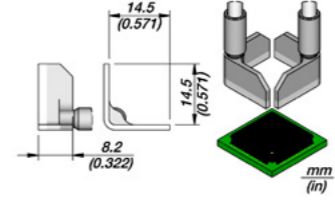
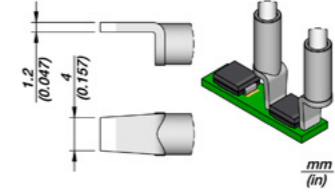



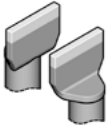
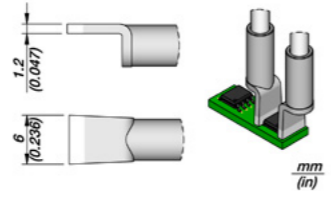
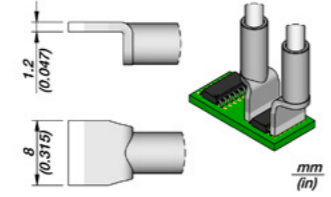
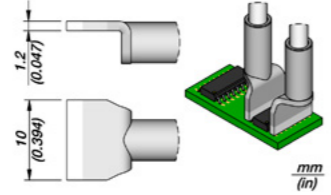
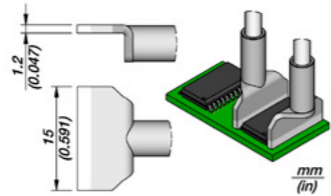
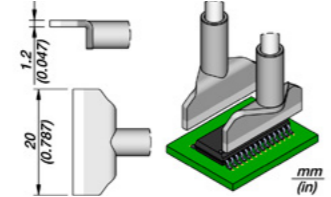
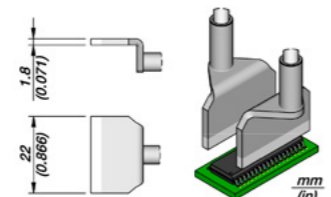

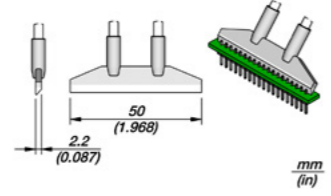
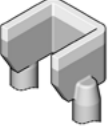
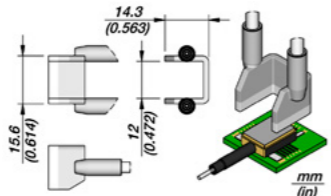
Ref.	Description	Image and dimensions	Suggested components	Compatible with
C420271	Chip Cartridge 1.5 mm 0.059 in		SMD resistors SMD capacitors	Stations: DI, DDE, DME Tools: AT420, HT420
C420287	Chip Cartridge 2 mm 0.079 in		Customized	Stations: DI, DDE, DME Tools: AT420, HT420
C420272	Chip Cartridge 2.6 mm 0.102 in		SMD resistors SMD capacitors	Stations: DI, DDE, DME Tools: AT420, HT420
C420279	QFP Cartridge 8 mm 0.315 in		QFP PLCC	Stations: DI, DDE, DME Tools: AT420, HT420
C420280	QFP Cartridge 11 mm 0.433 in		QFP PLCC	Stations: DI, DDE, DME Tools: AT420, HT420
C420288	QFP Cartridge 14.5 mm 0.571 in		QFP PLCC	Stations: DI, DDE, DME Tools: AT420, HT420
C420273	Blade Cartridge 4 mm 0.157 in		Package 1210, 1812 SO, SOT DIP	Stations: DI, DDE, DME Tools: AT420, HT420

C420 Cartridge Range for AT420 and HT420 Thermal Tweezers

	Ref.	Description	Image and dimensions	Suggested components	Compatible with
	C420274	Blade Cartridge 6 mm 0.236 in		DIP IC	Stations: DI, DDE, DME Tools: AT420, HT420
	C420275	Blade Cartridge 8 mm 0.315 in		DIP IC	Stations: DI, DDE, DME Tools: AT420, HT420
	C420276	Blade Cartridge 10 mm 0.394 in		DIP IC	Stations: DI, DDE, DME Tools: AT420, HT420
	C420277	Blade Cartridge 15 mm 0.591 in		DIP IC	Stations: DI, DDE, DME Tools: AT420, HT420
	C420278	Blade Cartridge 20 mm 0.787 in		DIP IC	Stations: DI, DDE, DME Tools: AT420, HT420
	C420285	Blade Cartridge 22 mm 0.866 in		DIP IC	Stations: DI, DDE, DME Tools: AT420, HT420
	C420283	Blade Cartridge 50 mm 1.968 in		Pad cleaning Connector desoldering	Stations: DI, DDE, DME Tools: AT420, HT420
	C420286	"U" Shape Cartridge 15.6 x 14.3 mm 0.614 x 0.563 in		Customized	Stations: DI, DDE, DME Tools: AT420, HT420

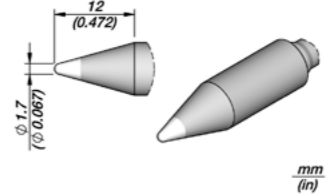
C470 Cartridge Range
for **T470 HD Handles** and **HT470 HD Thermal Tweezers**

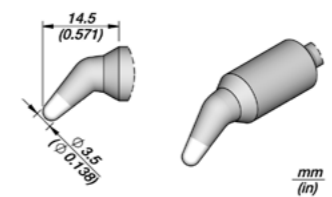

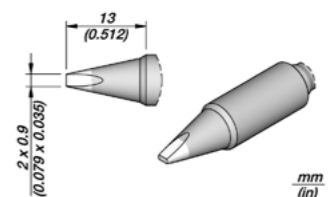
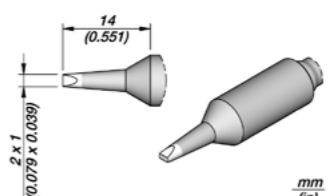
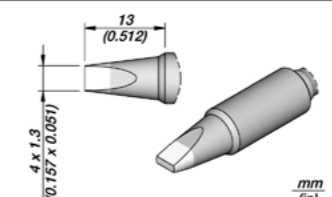
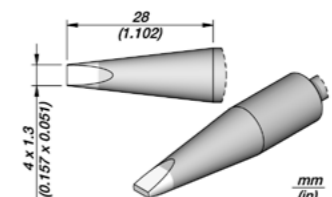
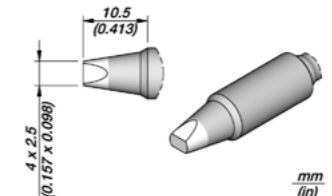
	Ref.	Description	Image and dimensions	Suggested components	Compatible with
	C470001	Conical Cartridge Ø 1.7 mm Ø 0.067 in		General use	Station: HDE Tools: T470, T470S, T470F, T470M, T470Z, T470N
	C470008	Conical Bent Cartridge Ø 3.5 mm Ø 0.138 in		General use	Station: HDE Tools: T470, T470S, T470F, T470M, T470Z, T470N
	C470013	Chisel Cartridge 2 x 0.9 mm 0.079 x 0.035 in		General use	Station: HDE Tools: T470, T470S, T470F, T470M, T470Z, T470N
	C470036	Chisel Cartridge 2 x 1 mm 0.079 x 0.039 in		General use	Station: HDE Tools: T470, T470S, T470F, T470M, T470Z, T470N
	C470014	Chisel Cartridge 4 x 1.3 mm S1 0.157 x 0.051 in		General use	Station: HDE Tools: T470, T470S, T470F, T470M, T470Z, T470N
	C470040	Chisel Cartridge 4 x 1.3 mm S2 0.157 x 0.051 in		General use	Station: HDE Tools: T470, T470S, T470F, T470M, T470Z, T470N
	C470035	Chisel Cartridge 4 x 2.5 mm 0.157 x 0.098 in		General use	Station: HDE Tools: T470, T470S, T470F, T470M, T470Z, T470N

C470 Cartridge Range for T470 HD Handles and HT470 HD Thermal Tweezers

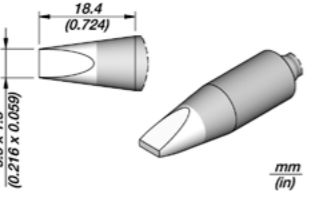
Ref.	Description	Image and dimensions	Suggested components	Compatible with
C470017	Chisel Cartridge 5 x 1.2 mm 0.197 x 0.047 in		General use	Station: HDE Tools: T470, T470S, T470F, T470M, T470Z, T470N
C470009	Chisel Cartridge 5.5 x 1.5 mm 0.216 x 0.059 in		General use Sheet metal	Station: HDE Tools: T470, T470S, T470F, T470M, T470Z, T470N
C470002	Chisel Cartridge 6 x 1.5 mm 0.236 x 0.059 in		General use Sheet metal	Station: HDE Tools: T470, T470S, T470F, T470M, T470Z, T470N
C470015	Chisel Cartridge 6 x 1.7 mm 0.236 x 0.067 in		General use	Station: HDE Tools: T470, T470S, T470F, T470M, T470Z, T470N
C470004	Chisel Cartridge 7.5 x 1.5 mm 0.295 x 0.059 in		General use Sheet metal	Station: HDE Tools: T470, T470S, T470F, T470M, T470Z, T470N
C470016	Chisel Cartridge 7.5 x 1.7 mm 0.295 x 0.067 in		General use	Station: HDE Tools: T470, T470S, T470F, T470M, T470Z, T470N
C470058	Chisel Cartridge 8 x 2.5 mm 0.315 x 0.098 in		General use Sheet metal	Station: HDE Tools: T470, T470S, T470F, T470M, T470Z, T470N
C470039	Chisel Cartridge 8.5 x 2.5 mm 0.335 x 0.098 in		General use Sheet metal	Station: HDE Tools: T470, T470S, T470F, T470M, T470Z, T470N



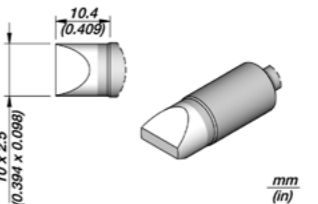
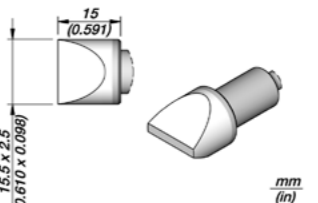
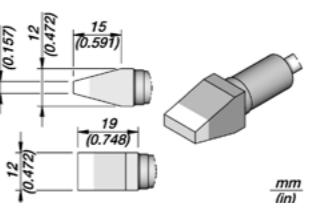
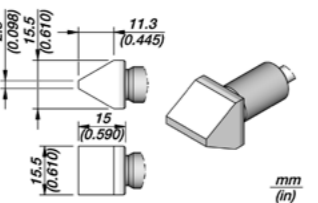
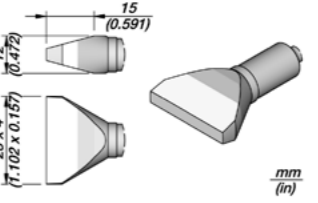
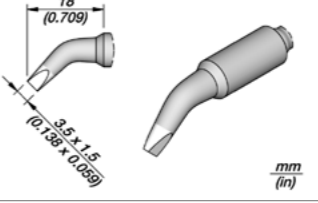
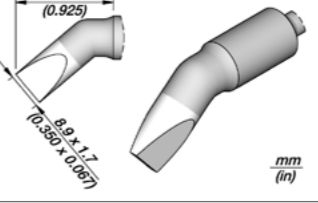
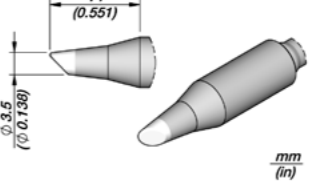

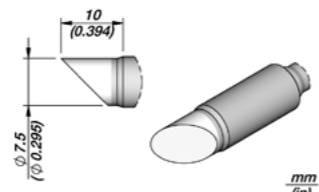
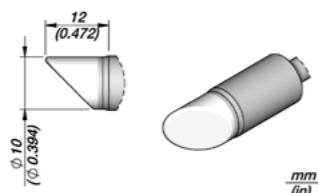
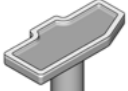
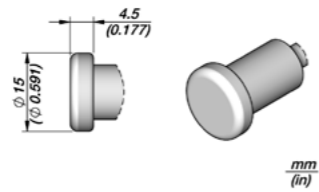
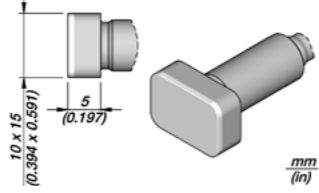
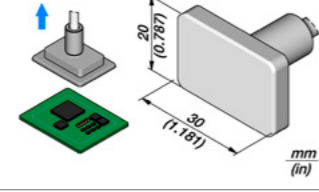
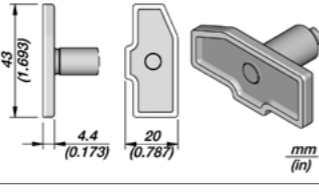
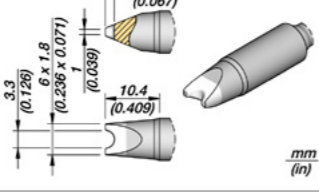
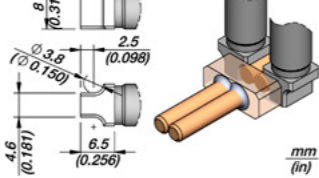

C470 Cartridge Range for T470 HD Handles and HT470 HD Thermal Tweezers

Ref.	Description	Image and dimensions	Suggested components	Compatible with
C470006	Chisel Cartridge 10 x 2.5 mm 0.394 x 0.098 in		General use Sheet metal	Station: HDE Tools: T470, T470S, T470F, T470M, T470Z, T470N
C470007	Chisel Cartridge 15.5 x 2.5 mm 0.610 x 0.098 in		General use Sheet metal	Station: HDE Tools: T470, T470S, T470F, T470M, T470Z, T470N
C470021	Chisel Cartridge 12 x 4 mm 0.472 x 0.157 in		General use Sheet metal	Station: HDE Tools: T470, T470S, T470F, T470M, T470Z, T470N
C470067	Chisel Cartridge 15.5 X 2.5 mm 0.610 x 0.098 in		General use Sheet metal	Station: HDE Tools: T470, T470S, T470F, T470M, T470Z, T470N, HT470
C470022	Chisel Cartridge 28 x 4 mm 1.102 x 0.157 in		Sheet metal	Station: HDE Tools: T470, T470S, T470F, T470M, T470Z, T470N
C470034	Chisel Bent Cartridge 3.5 x 1.5 mm 0.138 x 0.059 in		General use	Station: HDE Tools: T470, T470S, T470F, T470M, T470Z, T470N
C470018	Chisel Bent Cartridge 8.9 x 1.7 mm 0.350 x 0.067 in		General use Sheet metal	Station: HDE Tools: T470, T470S, T470F, T470M, T470Z, T470N
C470019	Bevel Cartridge Ø 3.5 mm Ø 0.138 in		General use	Station: HDE Tools: T470, T470S, T470F, T470M, T470Z, T470N

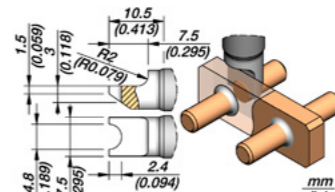
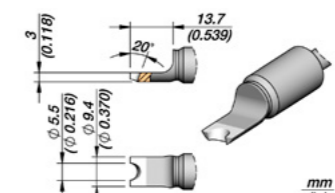
C470 Cartridges Range for T470 HD Handles and HT470 HD Thermal Tweezers

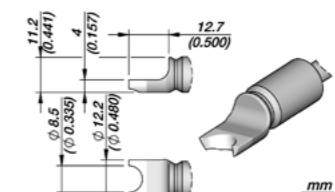
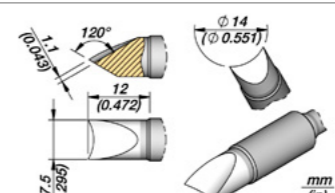
	Ref.	Description	Image and dimensions	Suggested components	Compatible with
	C470003	Bevel Cartridge Ø 7.5 mm Ø 0.295 in		General use Sheet metal	Station: HDE Tools: T470, T470S, T470F, T470M, T470Z, T470N
	C470056	Bevel Cartridge Ø 10 mm Ø 0.394 in		Wide area Shield desoldering Sheet metal	Station: HDE Tools: T470, T470S, T470F, T470M, T470Z, T470N
	C470005	Flat Cartridge Ø 15 mm Ø 0.591 in		Shield desoldering Metal PCB Sheet metal	Station: HDE Tools: T470, T470S, T470F, T470M, T470Z, T470N
	C470044	Flat Cartridge 10 x 15 mm 0.394 x 0.591 in		Shield desoldering Metal PCB Sheet metal	Station: HDE Tools: T470, T470S, T470F, T470M, T470Z, T470N
	C470057	Flat Cartridge 20 x 30 mm 0.787 x 1.181 in		Shield desoldering Metal PCB Sheet metal	Station: HDE Tools: T470, T470S, T470F, T470M, T470Z, T470N
	C470027	Shield Cartridge 43 x 20 mm 1.693 x 0.787 in		Shield desoldering	Station: HDE Tools: T470, T470S, T470F, T470M, T470Z, T470N
	C470031	Pin/Connector Cartridge Ø 3.3 mm Ø 0.126 in		Cable Through-hole	Station: HDE Tools: T470, T470S, T470F, T470M, T470Z, T470N
C470050	Pin/Connector Cartridge Ø 3.8 mm Ø 0.150 in		Cable Connectors	Station: HDE Tools: T470, T470S, T470F, T470M, T470Z, T470N, HT470	

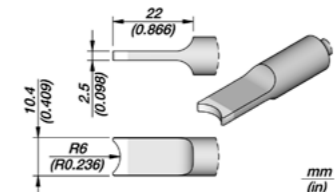
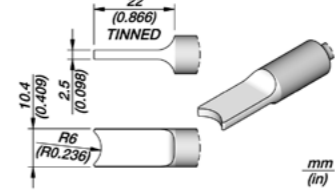
C470 Cartridges Range for T470 HD Handles and HT470 HD Thermal Tweezers

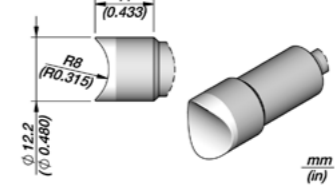
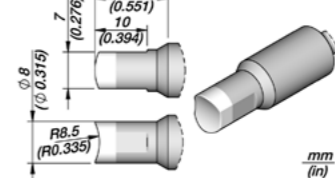
	Ref.	Description	Image and dimensions	Suggested components	Compatible with
	C470042	Pin/Connector Cartridge Ø 4.8 mm Ø 0.189 in		Cable Through-hole	Station: HDE Tools: T470, T470S, T470F, T470M, T470Z, T470N, HT470
	C470066	Pin/Connector Cartridge Ø 5.5 mm Ø 0.216 in		Cable Through-hole	Station: HDE Tools: T470, T470S, T470F, T470M, T470Z, T470N
	C470065	Pin/Connector Cartridge Ø 8.5 mm Ø 0.335 in		Cable Through-hole	Station: HDE Tools: T470, T470S, T470F, T470M, T470Z, T470N
	C470047	Pin/Connector Cartridge Ø 14 mm Ø 0.551 in		Cable Through-hole	Station: HDE Tools: T470, T470S, T470F, T470M, T470Z, T470N
	C470012	Pin/Connector Cartridge R. 6 mm S1 R. 0.236 in		Cables Connectors	Station: HDE Tools: T470, T470S, T470F, T470M, T470Z, T470N
	C470038	Pin/Connector Cartridge R. 6 mm S2 R. 0.236 in		Wide area Cables Connectors	Station: HDE Tools: T470, T470S, T470F, T470M, T470Z, T470N
	C470010	Pin/Connector Cartridge R. 8 mm R. 0.315 in		Cables connectors	Station: HDE Tools: T470, T470S, T470F, T470M, T470Z, T470N
	C470052	Pin/Connector Cartridge R. 8.5 mm R. 0.335 in		Cables connectors	Station: HDE Tools: T470, T470S, T470F, T470M, T470Z, T470N



C470 Cartridge Range for T470 HD Handles and HT470 HD Thermal Tweezers

Ref.	Description	Image and dimensions	Suggested components	Compatible with
C470029	Pin/Connector Cartridge R. 31 mm R. 1.220 in		Connectors	Station: HDE Tools: T470, T470S, T470F, T470M, T470Z, T470N
C470028	Barrel Cartridge Ø 1.2 mm Ø 0.047 in		Cable Through-hole	Station: HDE Tools: T470, T470S, T470F, T470M, T470Z, T470N
C470020	Barrel Cartridge Ø 2.4 mm Ø 0.094 in		Through-hole	Station: HDE Tools: T470, T470S, T470F, T470M, T470Z, T470N
C470048	Barrel Cartridge Ø 3.4 mm Ø 0.134 in		Cable Through-hole	Station: HDE Tools: T470, T470S, T470F, T470M, T470Z, T470N
C470033	Barrel Cartridge Ø 3.65 mm Ø 0.144 in		Cable Through-hole	Station: HDE Tools: T470, T470S, T470F, T470M, T470Z, T470N
C470055	Barrel Cartridge Ø 4 mm Ø 0.157 in		Cable Through-hole	Station: HDE Tools: T470, T470S, T470F, T470M, T470Z, T470N
C470049	Barrel Cartridge Ø 5.2 mm Ø 0.205 in		Cable Through-hole	Station: HDE Tools: T470, T470S, T470F, T470M, T470Z, T470N
C470030	Barrel Cartridge Ø 5 mm Ø 0.197 in		Cable Through-hole	Station: HDE Tools: T470, T470S, T470F, T470M, T470Z, T470N

C470 Cartridge Range for T470 HD Handles and HT470 HD Thermal Tweezers

Ref.	Description	Image and dimensions	Suggested components	Compatible with
C470037	Barrel Cartridge Ø 8 mm Ø 0.315 in		Cable Through-hole	Station: HDE Tools: T470, T470S, T470F, T470M, T470Z, T470N
C470041	Barrel Cartridge Ø 12.5 mm Ø 0.492 in		Cable Through-hole	Station: HDE Tools: T470, T470S, T470F, T470M, T470Z, T470N
C470064	Blade Cartridge 10 mm 0.394 in		Pad cleaning Connector desoldering	Station: HDE Tools: T470, T470S, T470F, T470M, T470Z, T470N, HT470
C470059	Blade Cartridge 20 mm 0.787 in		Pad cleaning Connector desoldering	Station: HDE Tools: T470, T470S, T470F, T470M, T470Z, T470N, HT470
C470023	Blade Cartridge 32 mm 1.260 in		Pad cleaning Connector desoldering	Station: HDE Tools: T470, T470S, T470F, T470M, T470Z, T470N, HT470
C470063	Blade Cartridge 37 mm 1.457 in		Pad cleaning Connector desoldering	Station: HDE Tools: T470, T470S, T470F, T470M, T470Z, T470N, HT470
C470046	Single Flat Cartridge 7.5 mm 0.295 in		General use Sheet metal	Station: HDE Tools: T470, T470S, T470F, T470M, T470Z, T470N, HT470
C470025	Cartridge for Plastics Ø 1.7 mm Ø 0.067 in		Plastics	Station: HDE Tools: T470, T470S, T470F, T470M, T470Z, T470N
C470026	Cartridge for Plastics Ø 3.5 mm Ø 0.138 in		Plastics	Station: HDE Tools: T470, T470S, T470F, T470M, T470Z, T470N

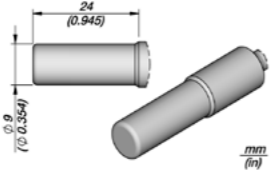
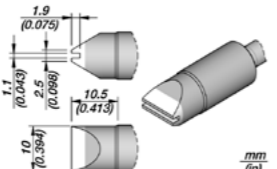
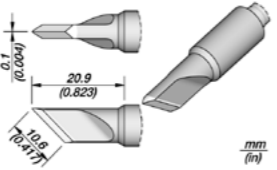
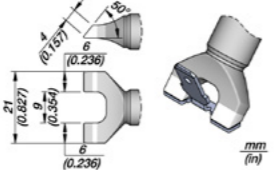
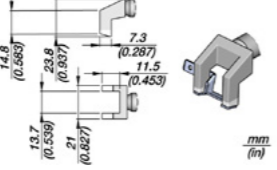
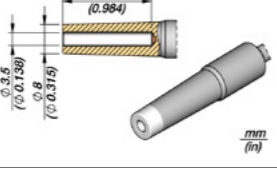
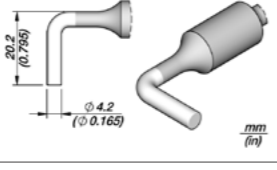
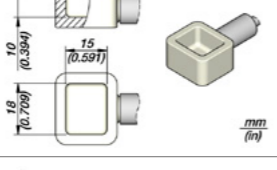
C470 Cartridge Range for T470 HD Handles and HT470 HD Thermal Tweezers

Ref.	Description	Image and dimensions	Suggested components	Compatible with
C470032	Cartridge for Plastics Ø 9 mm Ø 0.354 in		Plastics	Station: HDE Tools: T470, T470S, T470F, T470M, T470Z, T470N
C470043	Groove Cartridge 1.1 x 10 mm 0.043 x 0.394 in		Wire soldering	Station: HDE Tools: T470, T470S, T470F, T470M, T470Z, T470N
C470061	Knife Cartridge 10.6 mm 0.417 in		Drag Soldering	Station: HDE Tools: T470, T470S, T470F, T470M, T470Z, T470N
C470051	Blade Split Cartridge 21 mm 0.827 in		Connectors	Station: HDE Tools: T470, T470S, T470F, T470M, T470Z, T470N
C470070	Faston Terminal Cartridge 21 mm 0.827 in		Connectors	Station: HDE Tools: T470, T470S, T470F, T470M, T470Z, T470N
C470045	Pin Cartridge Ø 3.5 mm Ø 0.138 in		Through-hole Male connector	Station: HDE Tools: T470, T470S, T470F, T470M, T470Z, T470N
C470011	Hook Cartridge Ø 4.2 mm Ø 0.165 in		Difficult to reach	Station: HDE Tools: T470, T470S, T470F, T470M, T470Z, T470N
C470SP01	Solder Pot Cartridge 15 x 18 mm 0.591 x 0.709 in		Tinnig wires Desoldering Through-hole Multipin components	Station: HDE Tools: T470, T470S, T470F, T470M, T470Z, T470N
C470SP42	Solder Pot Cartridge 40 x 40 mm 1.575 x 1.575 in		Tinnig wires Desoldering Through-hole Multipin components	Station: HDE Tools: T470, T470S, T470F, T470M, T470Z, T470N

C360 Tip Range for DS360 Micro Desoldering Iron

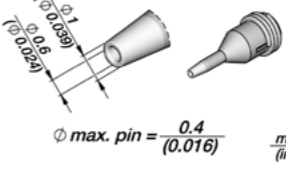
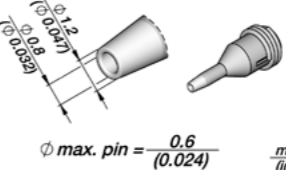
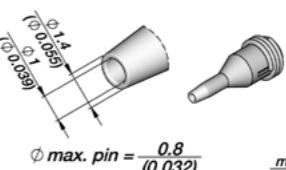
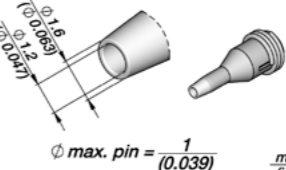
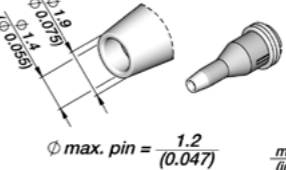
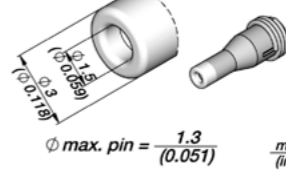
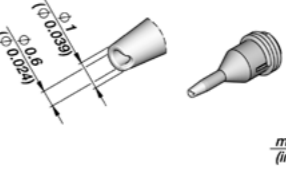

Ref.	Description	Image and dimensions	Suggested components	Compatible with
C360001	Micro Desoldering Tip Ø 0.6 mm Ø 0.024 in		Through-hole Desoldering	Stations: CS, DI, DDE, DME Tool: DS360 Modules: MSE, MS
C360002	Micro Desoldering Tip Ø 0.8 mm Ø 0.032 in		Through-hole Desoldering	Stations: CS, DI, DDE, DME Tool: DS360 Modules: MSE, MS
C360003	Micro Desoldering Tip Ø 1 mm Ø 0.039 in		Through-hole Desoldering	Stations: CS, DI, DDE, DME Tool: DS360 Modules: MSE, MS
C360004	Micro Desoldering Tip Ø 1.2 mm Ø 0.047 in		Through-hole Desoldering	Stations: CS, DI, DDE, DME Tool: DS360 Modules: MSE, MS
C360007	Micro Desoldering Tip Ø 1.4 mm Ø 0.055 in		Through-hole Desoldering	Stations: CS, DI, DDE, DME Tool: DS360 Modules: MSE, MS
C360006	Micro Desoldering Tip Ø 1.5 mm Ø 0.059 in		Through-hole Desoldering	Stations: CS, DI, DDE, DME Tool: DS360 Modules: MSE, MS
C360011	Micro Desoldering Tip Ø 0.6 mm Pad Ø 0.024 in		Pad desoldering	Stations: CS, DI, DDE, DME Tool: DS360 Modules: MSE, MS

C360 Tip Range for DS360 Micro Desoldering Iron

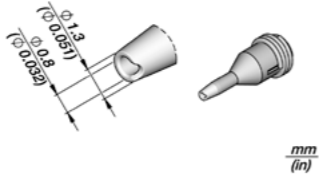
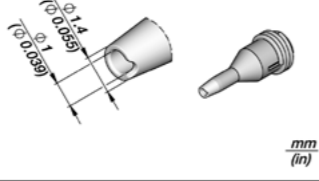
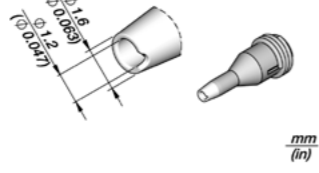

Ref.	Description	Image and dimensions	Suggested components	Compatible with
C360012	Micro Desoldering Tip Ø 0.8 mm Pad Ø 0.032 in		Pad desoldering	Stations: CS, DI, DDE, DME Tool: DS360 Modules: MSE, MS
C360013	Micro Desoldering Tip Ø 1 mm Pad Ø 0.039 in		Pad desoldering	Stations: CS, DI, DDE, DME Tool: DS360 Modules: MSE, MS
C360014	Micro Desoldering Tip Ø 1.2 mm Pad Ø 0.047 in		Pad desoldering	Stations: CS, DI, DDE, DME Tool: DS360 Modules: MSE, MS

C560 Tip Range for DR560 Desoldering Iron

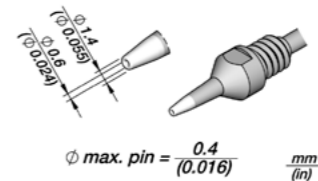
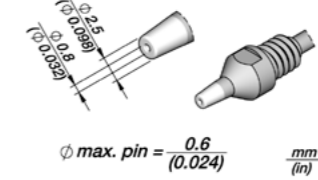
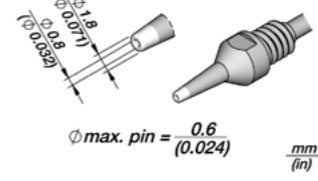
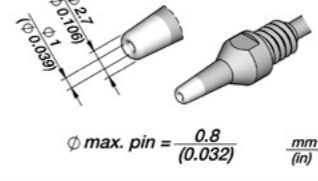
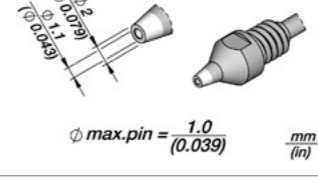
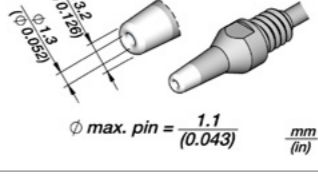
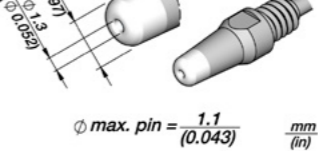

Ref.	Description	Image and dimensions	Suggested components	Compatible with
C560001	Desoldering Tip Ø 0.6 mm HT Ø 0.024 in		Through-hole Desoldering	Stations: DI, DDE, DME Tool: DR560 Modules: MSE, MS
C560014	Desoldering Tip Ø 0.8 mm Ø 0.032 in		Through-hole Desoldering	Stations: DI, DDE, DME Tool: DR560 Modules: MSE, MS
C560002	Desoldering Tip Ø 0.8 mm HT Ø 0.032 in		Through-hole Desoldering	Stations: DI, DDE, DME Tool: DR560 Modules: MSE, MS
C560003	Desoldering Tip Ø 1 mm Ø 0.039 in		Through-hole Desoldering	Stations: DI, DDE, DME Tool: DR560 Modules: MSE, MS
C560017	Desoldering Tip Ø 1.1 mm Ø 0.043 in		Through-hole Desoldering	Stations: DI, DDE, DME Tool: DR560 Modules: MSE, MS
C560004	Desoldering Tip Ø 1.3 x Ø 3.2 mm Ø 0.052 x Ø 0.126 in		Through-hole Desoldering	Stations: DI, DDE, DME Tool: DR560 Modules: MSE, MS
C560009	Desoldering Tip Ø 1.3 x Ø 5 mm Ø 0.052 x Ø 0.197 in		Through-hole Desoldering	Stations: DI, DDE, DME Tool: DR560 Modules: MSE, MS

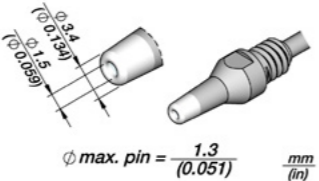
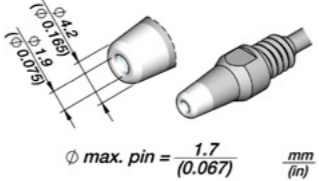
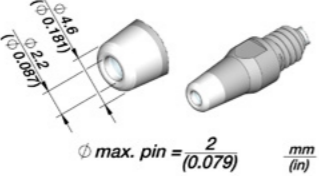
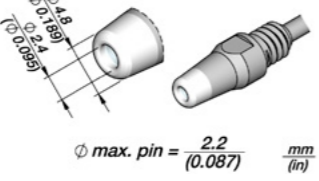
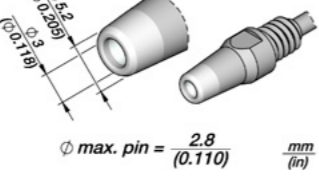
C560 Tip Range for DR560 Desoldering Iron

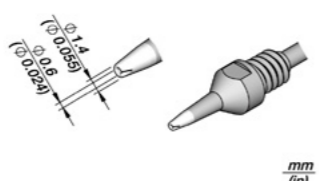
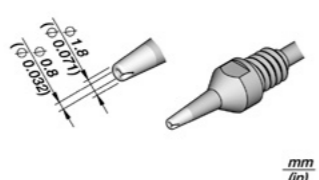
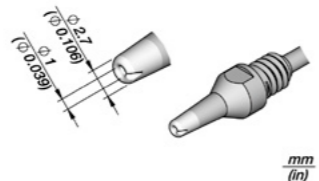
	Ref.	Description	Image and dimensions	Suggested components	Compatible with
	C560005	Desoldering Tip Ø 1.5 mm Ø 0.059 in	 $\phi \text{ max. pin} = \frac{1.3}{(0.051)} \frac{\text{mm}}{\text{(in)}}$	Through-hole Desoldering	Stations: DI, DDE, DME Tool: DR560 Modules: MSE, MS
	C560006	Desoldering Tip Ø 1.9 mm Ø 0.075 in	 $\phi \text{ max. pin} = \frac{1.7}{(0.067)} \frac{\text{mm}}{\text{(in)}}$	Through-hole Desoldering	Stations: DI, DDE, DME Tool: DR560 Modules: MSE, MS
	C560018	Desoldering Tip Ø 2.2 mm Ø 0.087 in	 $\phi \text{ max. pin} = \frac{2}{(0.079)} \frac{\text{mm}}{\text{(in)}}$	Through-hole Desoldering	Stations: DI, DDE, DME Tool: DR560 Modules: MSE, MS
	C560007	Desoldering Tip Ø 2.4 mm Ø 0.095 in	 $\phi \text{ max. pin} = \frac{2.2}{(0.087)} \frac{\text{mm}}{\text{(in)}}$	Through-hole Desoldering	Stations: DI, DDE, DME Tool: DR560 Modules: MSE, MS
	C560015	Desoldering Tip Ø 3 mm Ø 0.118 in	 $\phi \text{ max. pin} = \frac{2.8}{(0.110)} \frac{\text{mm}}{\text{(in)}}$	Through-hole Desoldering	Stations: DI, DDE, DME Tool: DR560 Modules: MSE, MS
		C560011	Desoldering Tip Ø 0.6 mm HT Pad Ø 0.024 in	 $\frac{\text{mm}}{\text{(in)}}$	Pad desoldering
C560012		Desoldering Tip Ø 0.8 mm HT Pad Ø 0.032 in	 $\frac{\text{mm}}{\text{(in)}}$	Pad desoldering	Stations: DI, DDE, DME Tool: DR560 Modules: MSE, MS
C560013		Desoldering Tip Ø 1 mm Pad Ø 0.039 in	 $\frac{\text{mm}}{\text{(in)}}$	Pad desoldering	Stations: DI, DDE, DME Tool: DR560 Modules: MSE, MS

W140 Blade Cartridge Range for WS140 High-Temperature Precision Wire Stripper Tweezers

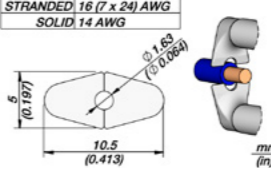
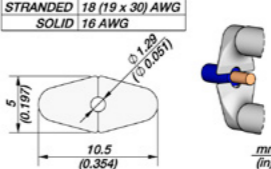
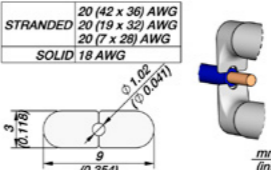
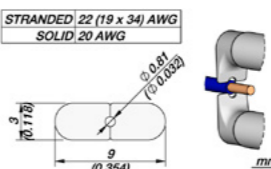
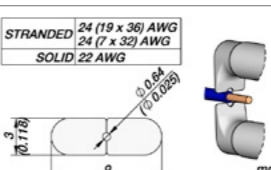
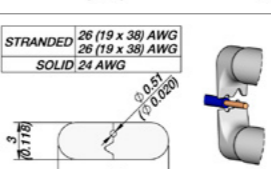
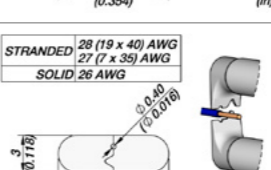
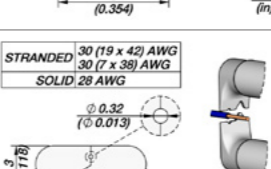

	Ref.	Description	Image and dimensions	Suggested components	Compatible with
	W14014G	Single-Hole Cartridges Solid Wire 14 AWG	 STRANDED 16 (7 x 24) AWG SOLID 14 AWG $\phi \text{ max. pin} = \frac{1.63}{(0.064)} \frac{\text{mm}}{\text{(in)}}$	Wire insulation stripping	Station: WSS Tool: WS140
	W14016G	Single-Hole Cartridges Solid Wire 16 AWG	 STRANDED 18 (19 x 30) AWG SOLID 16 AWG $\phi \text{ max. pin} = \frac{1.28}{(0.051)} \frac{\text{mm}}{\text{(in)}}$	Wire insulation stripping	Station: WSS Tool: WS140
	W14018G	Single-Hole Cartridges Solid Wire 18 AWG	 STRANDED 20 (42 x 36) AWG 20 (19 x 32) AWG SOLID 18 AWG $\phi \text{ max. pin} = \frac{1.02}{(0.041)} \frac{\text{mm}}{\text{(in)}}$	Wire insulation stripping	Station: WSS Tool: WS140
	W14020G	Single-Hole Cartridges Solid Wire 20 AWG	 STRANDED 22 (19 x 34) AWG SOLID 20 AWG $\phi \text{ max. pin} = \frac{0.91}{(0.036)} \frac{\text{mm}}{\text{(in)}}$	Wire insulation stripping	Station: WSS Tool: WS140
	W14022G	Single-Hole Cartridges Solid Wire 22 AWG	 STRANDED 24 (19 x 36) AWG 24 (7 x 32) AWG SOLID 22 AWG $\phi \text{ max. pin} = \frac{0.84}{(0.033)} \frac{\text{mm}}{\text{(in)}}$	Wire insulation stripping	Station: WSS Tool: WS140
	W14024G	Single-Hole Cartridges Solid Wire 24 AWG	 STRANDED 26 (19 x 38) AWG 26 (19 x 38) AWG SOLID 24 AWG $\phi \text{ max. pin} = \frac{0.81}{(0.032)} \frac{\text{mm}}{\text{(in)}}$	Wire insulation stripping	Station: WSS Tool: WS140
	W14026G	Single-Hole Cartridges Solid Wire 26 AWG	 STRANDED 28 (19 x 40) AWG 27 (7 x 35) AWG SOLID 26 AWG $\phi \text{ max. pin} = \frac{0.46}{(0.018)} \frac{\text{mm}}{\text{(in)}}$	Wire insulation stripping	Station: WSS Tool: WS140
	W14028G	Single-Hole Cartridges Solid Wire 28 AWG	 STRANDED 30 (19 x 42) AWG 30 (7 x 38) AWG SOLID 28 AWG $\phi \text{ max. pin} = \frac{0.32}{(0.013)} \frac{\text{mm}}{\text{(in)}}$	Wire insulation stripping	Station: WSS Tool: WS140

W140 Blade Cartridge Range for WS140 High-Temperature Precision Wire Stripper Tweezers

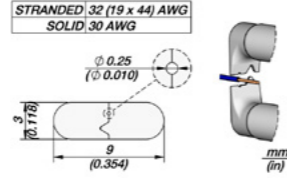
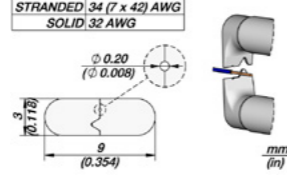
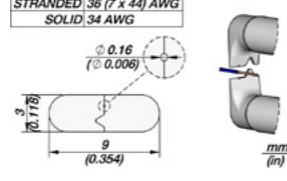
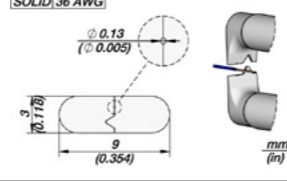
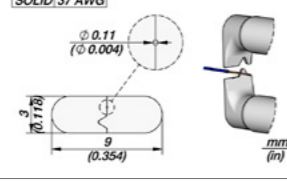
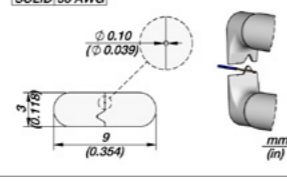
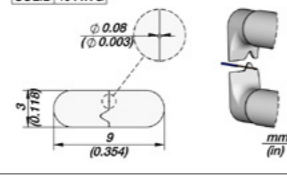
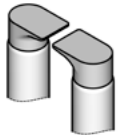
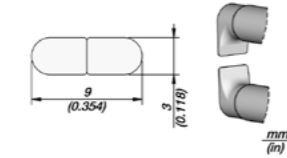
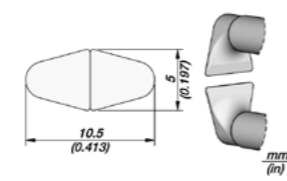
	Ref.	Description	Image and dimensions	Suggested components	Compatible with
	W14030G	Single-Hole Cartridges Solid Wire 30 AWG		Wire insulation stripping	Station: WSS Tool: WS140
	W14032G	Single-Hole Cartridges Solid Wire 32 AWG		Wire insulation stripping	Station: WSS Tool: WS140
	W14034G	Single-Hole Cartridges Solid Wire 34 AWG		Wire insulation stripping	Station: WSS Tool: WS140
	W14036G	Single-Hole Cartridges Solid Wire 36 AWG		Wire insulation stripping	Station: WSS Tool: WS140
	W14037G	Single-Hole Cartridges Solid Wire 37 AWG		Wire insulation stripping	Station: WSS Tool: WS140
	W14038G	Single-Hole Cartridges Solid Wire 38 AWG		Wire insulation stripping	Station: WSS Tool: WS140
	W14040G	Single-Hole Cartridges Solid Wire 40 AWG		Wire insulation stripping	Station: WSS Tool: WS140
		W14003F	Flat Cartridges 3 mm		Wire insulation stripping
W14005F		Flat Cartridges 5 mm		Wire insulation stripping	Station: WSS Tool: WS140

W440 Blade Cartridge Range for WS440 High-Temperature Wire Stripper Tweezers

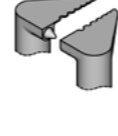
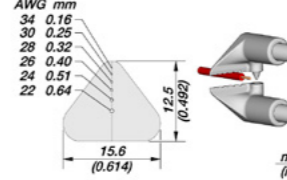
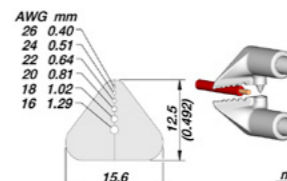
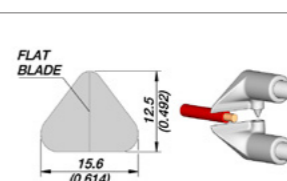

	Ref.	Description	Image and dimensions	Suggested components	Compatible with
	W440021	Multi-Hole Cartridges Solid Wire 34 - 22 AWG		Wire insulation stripping	Station: WSB Tool: WS440
	W440023	Multi-Hole Cartridges Solid Wire 26 - 16 AWG		Wire insulation stripping	Station: WSB Tool: WS440
	W440025	Flat Cartridges 12.5 mm		Wire insulation stripping	Station: WSB Tool: WS440

