

Brushless Delvo C Series (Current control type) Model DLV04C/10C

***Four fastening settings
can be set on one screwdriver!***



DCC0101X



DLV04C



DLV10C



- **Current Controlled Torque System**
- **Low-voltage Brushless Motor**
- **ESD (Electro-Static Discharge) protection**
- **For Both Hand-held / Automatic Machines**
- **Built-in Screw Counting Function**

Four screwdrivers can be consolidated

1st unit



0.25 Nm
450 min⁻¹

Torque : 0.05 - 0.4 Nm (DLV04C)
[0.44 - 3.54 lbf·in]

0.2 - 1.0 Nm (DLV10C)
[1.77 - 8.85 lbf·in]

Speed : 100 - 1000 min⁻¹

2nd unit



0.15 Nm
600 min⁻¹

3rd unit



0.35 Nm
1000 min⁻¹

4th unit



0.30 Nm
450 min⁻¹

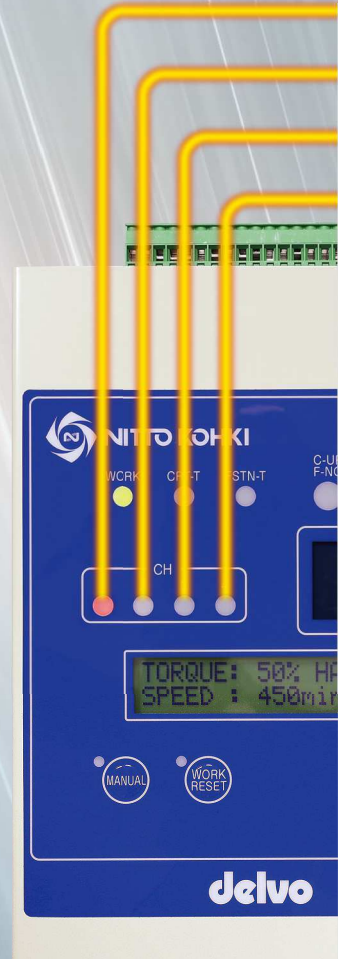

Comparison of Adjustment Method with Conventional Model

Torque adjustment

Conventional



Torque is adjusted by turning the adjustment ring at the end of the screwdriver.



Brushless Delvo C Series



Can be set with the external controller. No need to adjust the screwdriver body.

Speed setting

Conventional



The speed of transformerless type screwdrivers is fixed for each series.



Brushless Delvo C Series



Can be set with the external controller. Adjustable between 100 to 1000 min⁻¹.

into one

Controller can be set to any torque and speed within range.

* The range varies depending on SOFT fastening or HARD fastening (see page 4).

* When the same bit is used.

All in one!



Easily adapts for use in automatic machines

The sequencing of the screwdrivers can be controlled by a PLC.



For installation on automatic assembly machines, attach optional flange coupling (DLW9015) or vacuum pickup (DLP6650).

Built-in Screw Fastening Counter Function

Controller has built in counting function. Prevents human errors.



Electric Current Control Function Explained

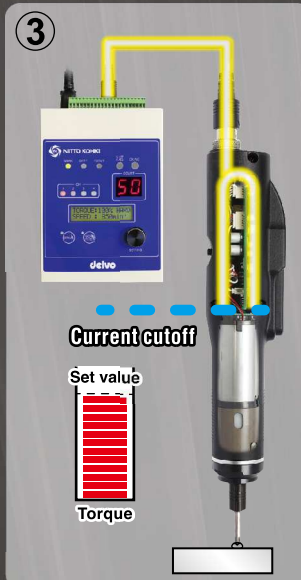
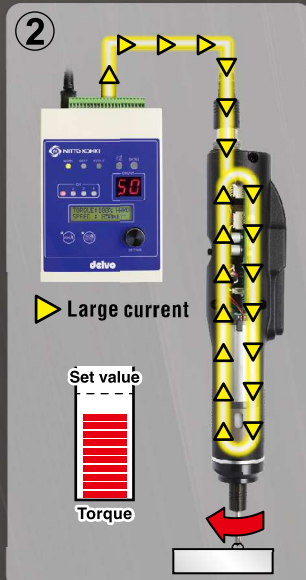

① Start of fastening

At start-up, a small amount of current is allowed.

② During fastening

As the load increases during fastening, so does the amount of current allowed.

③ End of fastening

When the desired current value (adjusted by corresponding torque value) is reached, current flow is cut off and the screwdriver stops.

Specifications of Electric Screwdriver and Controller

Specifications (Electric Screwdriver)

Model	DLV04C10L-AZ K	DLV10C10L-AZ K
Torque	SOFT fastening setting (1000 min ⁻¹ setting)	0.05 - 0.4 [0.44 - 3.54]
	SOFT fastening setting (600 min ⁻¹ setting)	0.05 - 0.35 [0.44 - 3.09]
(Nm [lbf·in])	HARD fastening setting	0.2 - 1.0 [1.77 - 8.85]
	HARD fastening setting	0.2 - 1.0 [1.77 - 8.85]
Free Speed (min ⁻¹)	SOFT fastening setting	600 - 1000
	HARD fastening setting	600 - 1000
Screw Size (mm)	Machine screw	1.2 - 3.0 [0.05" - 0.12"]
	Tapping screw	1.1 - 2.5 [0.04" - 0.10"]
Bit Type	NK35(OD6.35 mm [1/4"] Hex. Shank)	
Input Voltage	24 V DC	
Mass	0.37 kg [0.82 lbs]	
Rated Operation	ON: 0.5 seconds / OFF: 3.5 seconds	

Specifications (Controller)

Model	DCC0101X-AZ P
Input Voltage	AC100 - 240 V AC, 50/60Hz
Operation Channel Function	Torque and speed setting in 4-channel memory Can switch to any operation channel
Count Function	Tracks screws fastened Workpiece detector can be incorporated
External Start up Control Function	Start up control can be enabled by external input signal
Input Signal Method	Photocoupler input (24 V DC drive (5 mA/1 input), respond to PNP output)
Output Signal Method	Photocoupler output (30 V DC or less, 30 mA/1 output or less, PNP output method)
Service Power Source	24 V DC (Maximum capacity 200 mA)
Power consumption	When on standby: 20 W During electric screwdriver rotation (rated): 30 W
Mass	1.1 kg [2.4 lbs]
Power cord (Optional)	DLW9220 / DLW9240 / DLW9250

Torque Measuring Equipment

Torque Checker	DLT1173A
Measurement bit	NK35 (No.2 x 4 x 75) • For the bit tip shape, use "+No.2"
Screw Joint for SOFT Fastening Setting*	DLW4540(with white rubber) DLW4550(with black rubber)
Screw Joint for HARD Fastening Setting	DLW4560 (with metal washer)

* Please use white rubber for DLV04C10L-AZ, black rubber for DLV10C10L-AZ measurement.

Caution

- Speed and torque differs depending on the temperature. (Use within the range of +10 to +40 °C.)
- Do not retighten screws that are already tightened. The torque will become larger than the set torque.
- Please purchase the power cord for the controller separately (see page 5).
- For torque measurements, please use Nitto Kohki's torque checker and screw joint (optional accessories).

LED Display of Electric Screwdriver and Controller

Notifies the OK or NG operation and settings by the LED lighting or blinking.

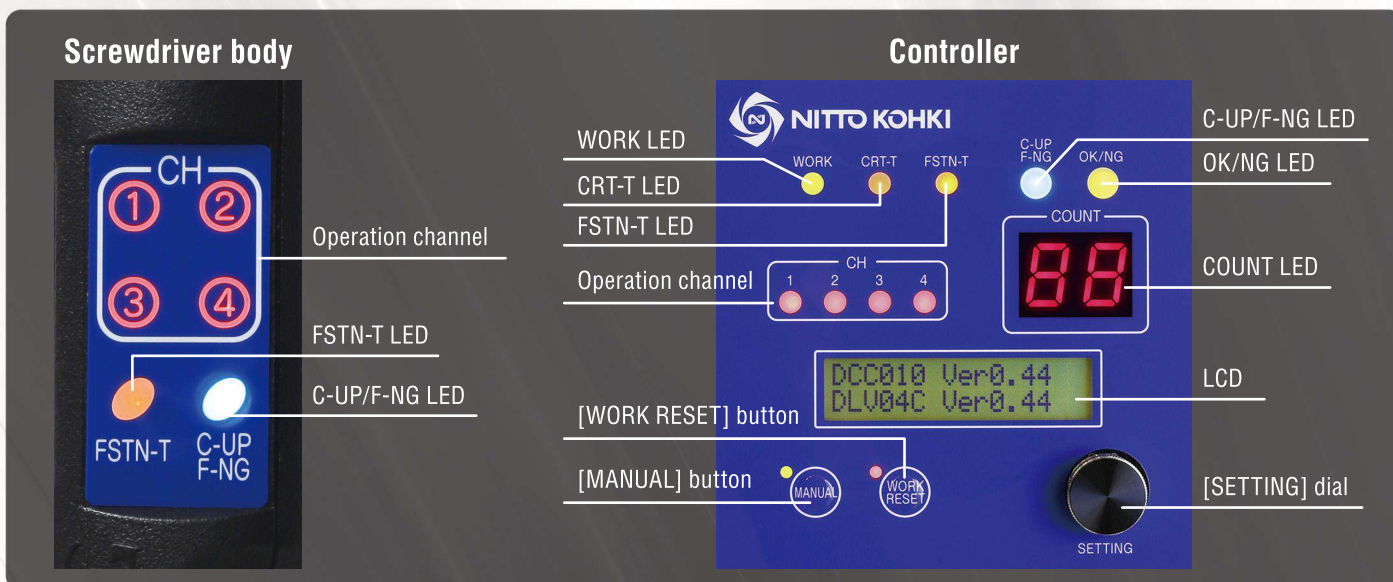

LCD display

The status and setting content are displayed in the controller LCD.

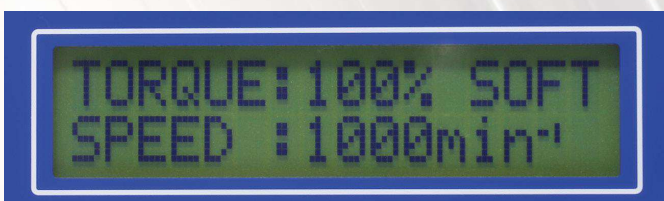

SOFT / HARD Fastening Settings

Two types of fastening mode available subject to the workpiece. Coordinate the actual workpieces, screws and operating conditions and determine the fastening mode.

SOFT fastening setting

Suitable for workpieces with high fastening load such as tapping screws or fastening soft objects such as rubber.

HARD fastening setting

Suitable for workpieces with small fastening load such as threaded holes or rigid bodies such as metal.

Timing chart

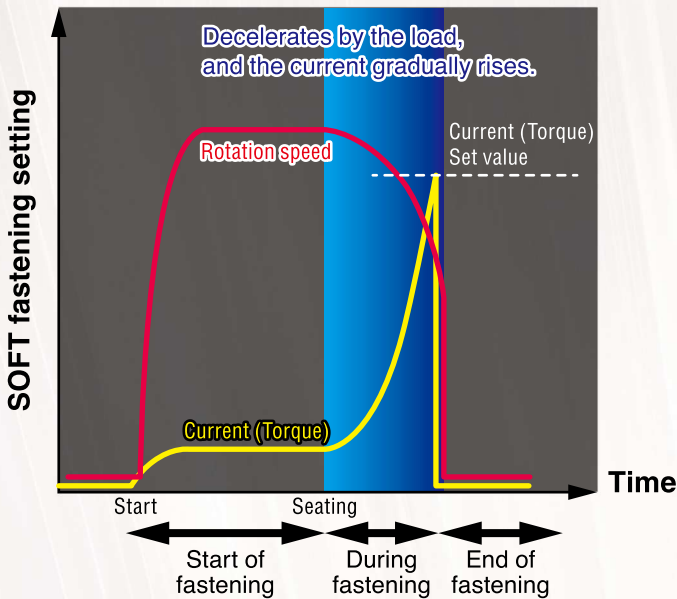

Start of fastening

After starting the screwdriver, it rotates at the set speed.

During fastening

As it screws in, the load gradually increases and the current value (torque) also rises.

End of fastening

When the screw is fastened completely and reaches the set current value (torque), the current will be cut off.

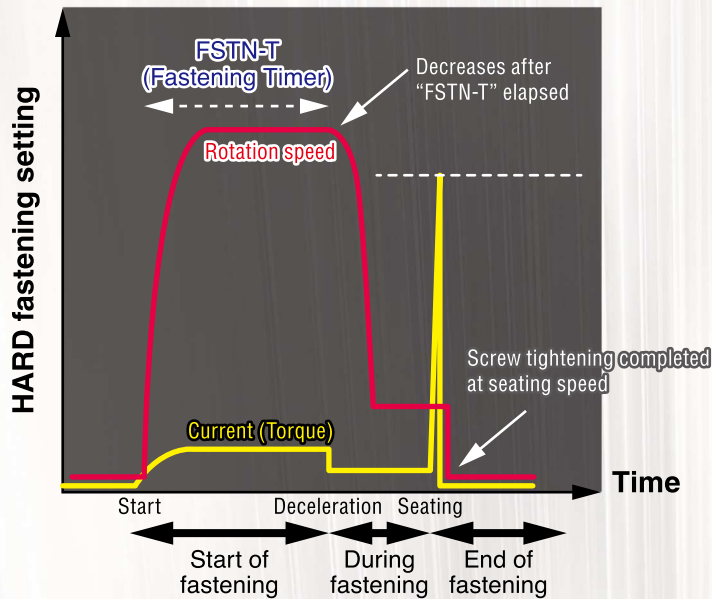

Start of fastening

After starting the screwdriver, it rotates at the set speed during FSTN-T (fastening timer) time.

During fastening

Fastens without load, and switches to the seating speed according to the torque set value just before seating the screw.

End of fastening

When the screw is fastened completely with the seating speed and reaches the set current value, the current will be cut off.

FSTN-T (Fastening Timer)

Can be set when "HARD" fastening setting is selected. By increasing the rotation speed during no-load fastening time prior to seating, the overall fastening time is reduced.

- ① Example with Fastening Timer
Speed : 800 min⁻¹
Torque : 15%
Fastening Timer : **0.5 sec**
- ② Example without Fastening Timer
Torque : 15%
Fastening Timer : **0 sec**

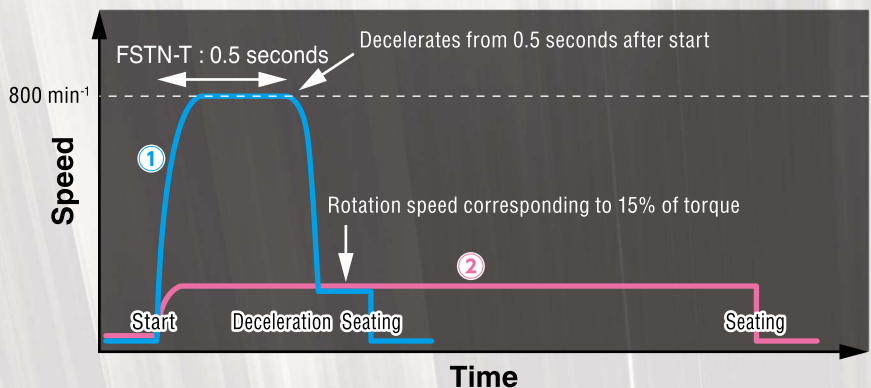

Graph of output torque and rotation speed

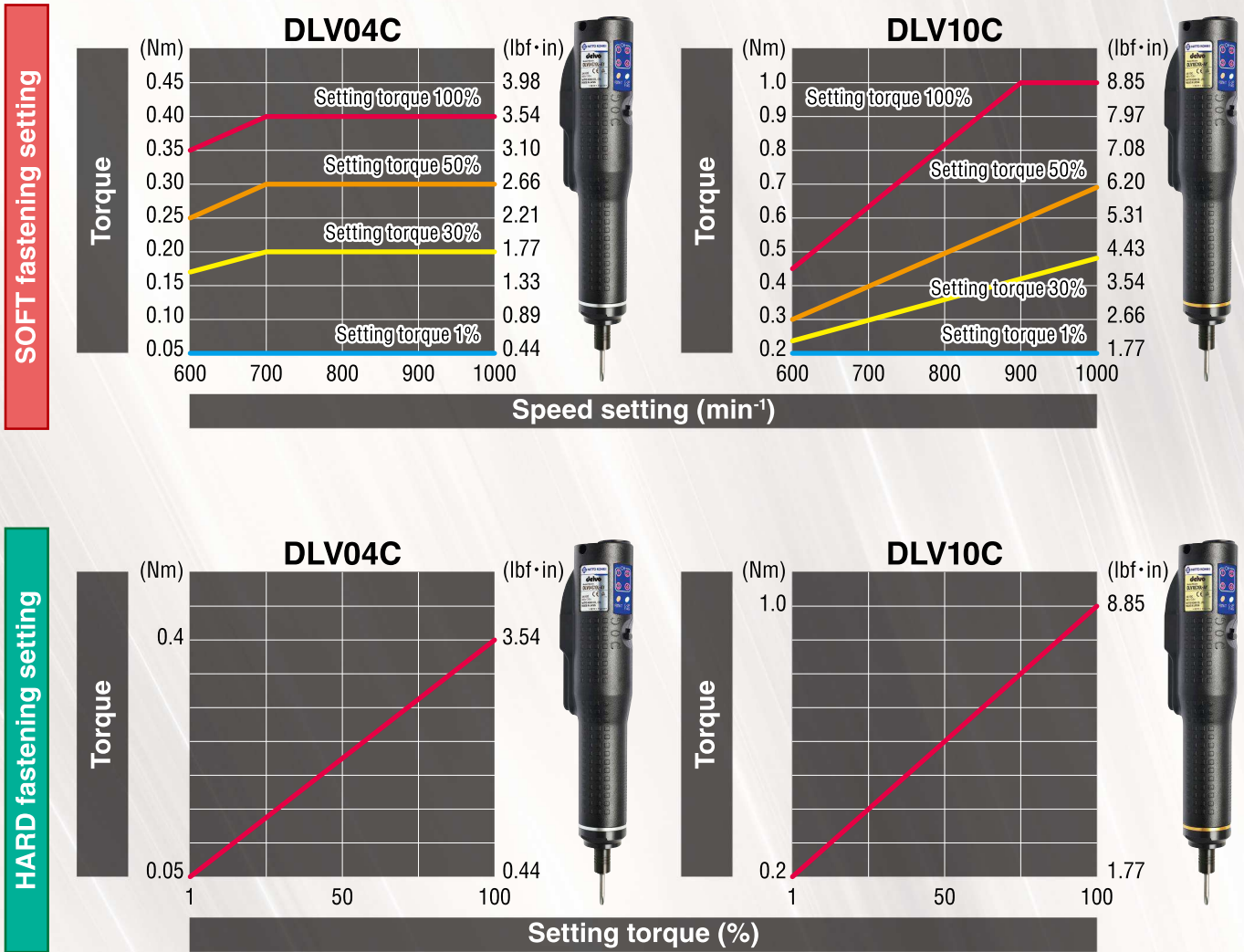

*The graph is for guidance only. The output torque range is not guaranteed.

Optional Accessories

Power cord (North America)



DLW9220

Power cord (Europe)



DLW9240

Power cord (UK)



DLW9250

Screw vacuum pump
Connect the tube to the vacuum pickup port. The vacuum will pick up the screw.



DLP2530 (100V), DLP2570 (230V)

Torque checker



DLT1173A

Screw joint (with white rubber)
*For DLV04C10L-AY SOFT fastening torque measurement



DLW4540

Screw joint (with black rubber)
*For DLV10C10L-AY SOFT fastening torque measurement



DLW4550

Screw joint (with metal washer)
*For HARD fastening torque measurement of both DLV04/10C10L-AY



DLW4560

External Signals

You can input or output external signals via a signal terminal block.

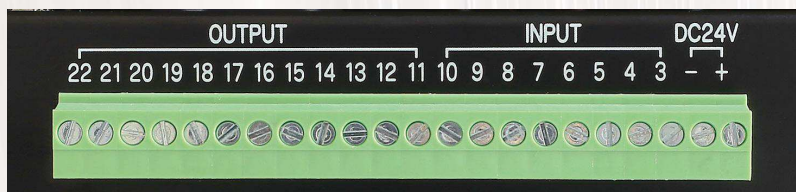
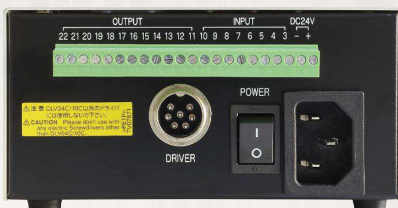

Terminal No.	Function	Details	I/O
1 (+)	+24 V DC	Built-in service power source (Capacity: Maximum 200 mA)	Service power source
2 (-)	0 V DC	• Use in power source for input/output signal common wire, or for the workpiece detection sensor, etc.	
3	Channel A	In the 2-bit input signal, specify the operation channel (CH1 to CH4) • Valid only when "operation channel switching method" (No.1 CH-CHG) is set to "INPUT"	Input
4	Channel B		
5	Forward rotation startup	Startup with external input signal	
6	Reverse rotation startup		
7	WORK	Input the workpiece signal (workpiece detection sensor output) • With "count function" (No.11 COUNT-FNC) and "workpiece signal" (No.12 WORK-SNSR) set to ON, the workpiece signal input is valid	
8	WORK RESET	Reset operation (same as controller [WORK RESET] button)	
9	Keylock	Lock the controller button operation • Disable the controller button operation, and prevent setting changes by the operator	
10	Input signal negative common wire	Connect 0 V DC* • Service power source (terminal No.2) or external 0 V DC power source can be connected	Output
11	Forward rotation signal	Set output signal during forward rotation to ON	
12	Reverse rotation signal	Set output signal during reverse rotation to ON	
13	Count-up (C-UP)	Performance of normal screw tightening (torque-up) sets output signal to 0.3 seconds ON	
14	Screw fastening NG (F-NG)	If screw fastening NG, sets output signal to 0.3 seconds ON	
15	Operation channel 1 (CH1)	Set the channel output signal to ON during operation or settings	
16	Operation channel 2 (CH2)		
17	Operation channel 3 (CH3)		
18	Operation channel 4 (CH4)		
19	Operation OK	If the set count screw tightening is judged to be completed and operation OK, the output signal is set to ON	
20	Operation NG	When the WORK input signal is OFF during an operation, and the operation is judged to be NG, the output signal is ON	
21	Space	Connection impossible	
22	Output signal positive common wire	Connect +24 V DC* • Service power source (terminal No.1) or external +24 V DC can be connected	

*When PNP output

Optional Accessories

Vacuum pickup



DLP6640

Vacuum pickup (for automatic machine)



DLP6650

Flanged coupling (for automatic machine)



DLW9015

When vacuum pickup for automatic machine DLP6650 is mounted

Adjust in accordance with the screw or bit

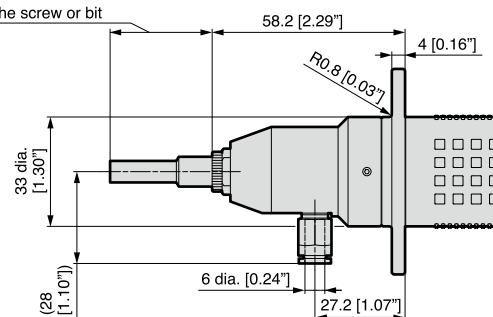

When only flanged coupling is mounted

When a 75 mm [2.95"] bit is mounted

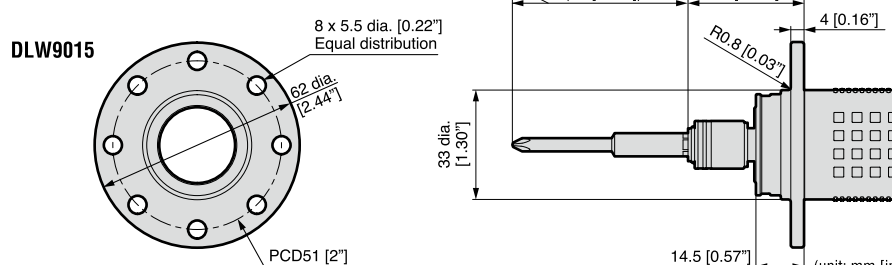

Brushless Delvo C Series

External dimensions

DLV04C10L
DLV10C10L

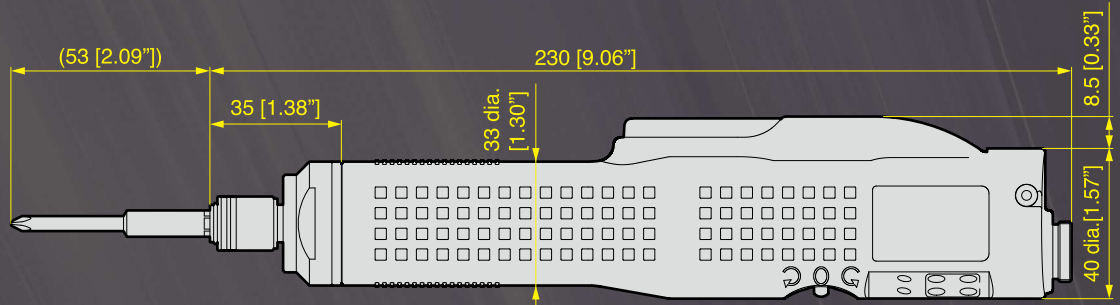

DCC0101X

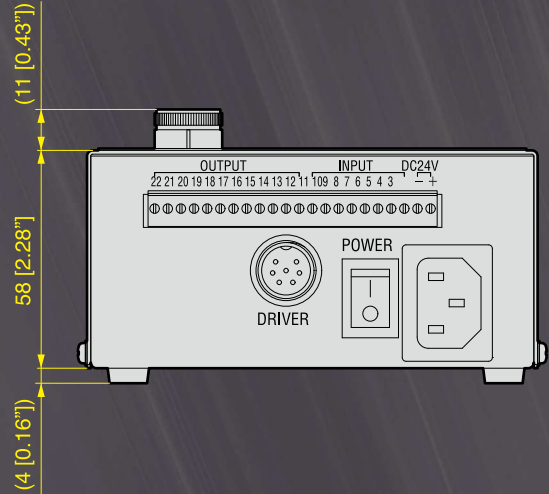
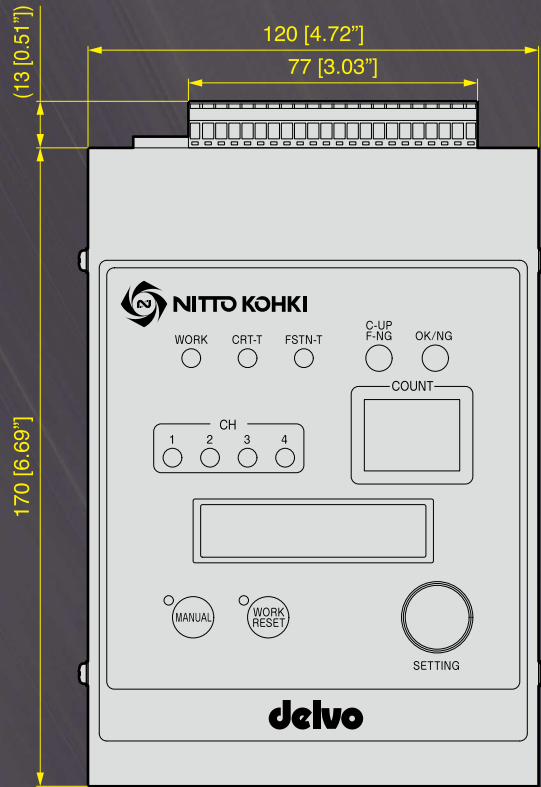

(unit: mm [inch])

Focused on you
NITTO KOHKI CO., LTD.
Web www.nitto-kohki.co.jp/e

Head Office
9-4, Nakaikegami 2-chome, Ohta-ku, Tokyo 146-8555, Japan
Tel : +81-3-3755-1111 Fax : +81-3-3753-8791
E-mail : overseas@nitto-kohki.co.jp

DISTRIBUTED BY